

KELEN

KE00-LX9 KELEN PP-RCT LX-SENSO pipe - PN20 32x5.4

1532091

Areas of application

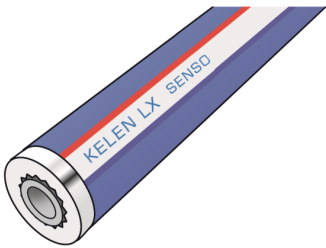

KELEN PP-RCT SENSO drinking water pipe system conforming to ÖNORM EN ISO 15874 made of polypropylene (PP-RCT) with factory-installed 9mm soft-foam insulation, can be located electronically; outer layer consisting of woven tape fabric and viscoplastic polymer alloy

Application area: 20°C/20 bar - 70°C/10 bar

Length: 4m

Approvals:



Specifications

Article information

port 1 Rohrende

port 2 Rohrende

Technical properties

isolation thickness 9 mm

pipe weight 0,50 kg/m

pipe contents 0,35 l/m

thermal conductivity 0,039 W/(m.K)

diameter inner tube 32 mm

PN PN 20

Product information

DIM2 21,2

VPE1 32,00 BND

VPE2 1280,00 HOB

L 4 m

weight 0,522 KGM

text KELEN PP-RCT LX-SENSO pipe - PN20

INTRNR 39172290

main material group KELEN

material group KELEN-LX pipes

code KE00-LX9

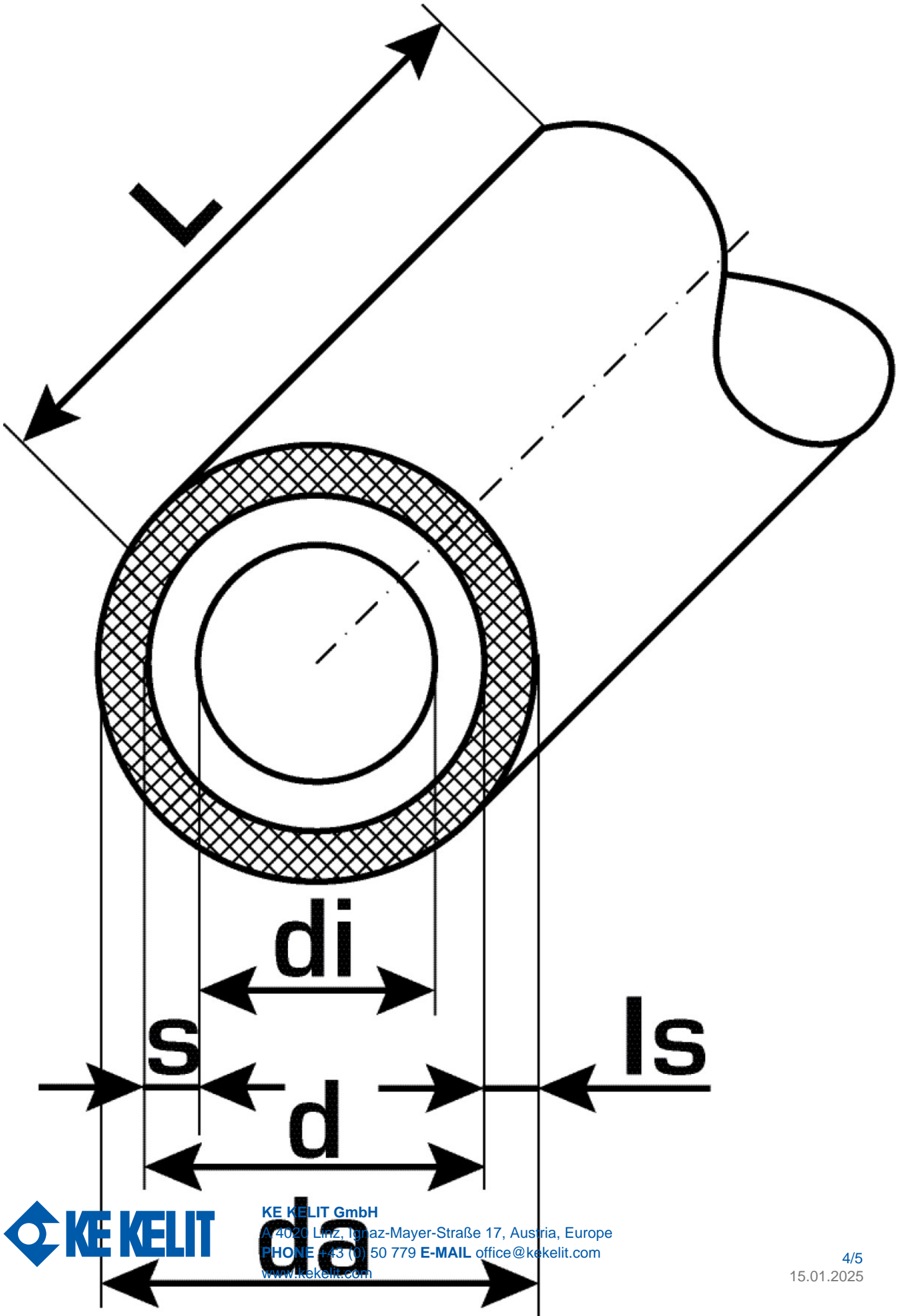

Art. No	label	d mm	d mm	d1 mm	pipe contents l/m	s mm
1532091	32x5.4	21,2	21,2	32	0,35	5,4



KE KELIT GmbH

A 4020 Linz, Ignaz-Mayer-Straße 17, Austria, Europe

PHONE +43 (0) 50 779 **E-MAIL** office@kekelit.com

www.kekelit.com