

KELEN

KE55 KELEN PP-RCT union plastic/metal male 63x2"

2744501

Areas of application

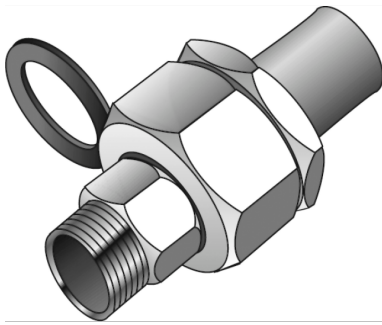

KELEN PP-RCT Polyfusion welding fitting, male, made from dezincification-resistant brass and non-porous metal-plating, flat sealing, incl. EPDM seal, thread conforms to ÖNORM EN 10226 plastic socket or EPDM seal separately available!

Approvals:



KE KELIT GmbH

A 4020 Linz, Ignaz-Mayer-Straße 17, Austria, Europe

PHONE +43 (0) 50 779 E-MAIL office@kekelit.com

www.kekelit.com

Specifications

Article information

port 1	Kunststoffschweißmuffe
port 2	Außengewinde konisch (NPT)
design	gerade

Product information

VPE1	1,00 SA1
VPE2	7,00 KT1
VPE3	28,00 KT2
VPE4	672,00 PAL
weight	1,443 KGM
text	KELEN PP-RCT union plastic/metal male
INTRNR	39174000
main material group	KELEN
material group	KELEN metal fittings
code	KE55



Art. No	label	d2	d1 mm	L1 mm	L2 mm	z1 mm	z2 mm	slw1 mm	slw2
2744501	63x2"	2"	63	87	65	35	39	86	86