

# KELEN

## K19K KELIT seal set for loose flange KE18 - KE18 20 4-hole

2731710

### Areas of application

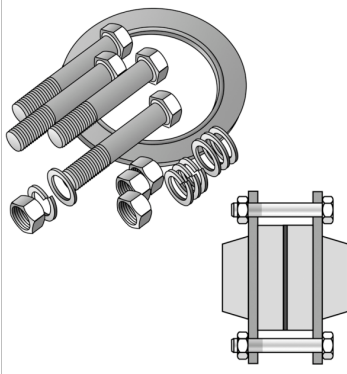

Incl. screws, nuts, washers, shims and EPDM seal with steel insert, screw length aligned with 2 units  
KE18 collar bushing with 2 units K19 loose flange  
EPDM seal with steel insert separately available!

### Approvals:



# Specifications

Product information	
VPE1	1,00 SA1
weight	0,428 KGM
text	KELIT seal set for loose flange KE18 - KE18
INTRNR	84849000
main material group	KELEN
material group	KELEN accessories
code	K19K

Art. No	label
2731710	20 4-hole