

# KELOX

## KM110 ?KELOX multilayer pipe 63x6 /5m

7410630

### Areas of application

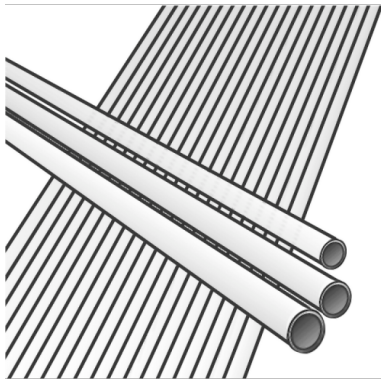

?KELOX multilayer pipe conforming to ÖNORM EN ISO 21003, oxygen-and water vapour diffusion-tight 5-layer PE-RT/Al/PE-RT composite pipe

Operating conditions classified acc. to ÖNORM EN ISO 21003

Sanitary application - Class 2: 70°C - tmax 80°C/10 bar

Radiator connection - Class 5: 80°C - tmax 90°C/10 bar

Colour: white/transparent

Rod length: 5m

## Approvals:



# Specifications

## Article information

**color** White

**flexible** 1

## Technical properties

**maximum working pressure at 20 ° C** 10 bar

**pipe weight** 1,25 kg/m

**pipe contents** 2,043 l/m

**lambda pipe** 0,45 W/(m.K)

**wall rawness** 0,007 mm

**expansion coefficient** 0,025 mm/(m.K)

## Product information

**VPE1** 15,00 BND

**VPE2** 420,00 HOB

**L** 5 m

**weight** 1,284 KGM

**text** ?KELOX multilayer pipe

**INTRNR** 39173900

**main material group** KELOX

**material group** KELOX pipes

**code** KM110



Art. No	label	d1 mm	pipe contents l/m	s mm
7410630	63x6 /5m	63	2,043	6



**KE KELIT GmbH**

A 4020 Linz, Ignaz-Mayer-Straße 17, Austria, Europe

**PHONE** +43 (0) 50 779 **E-MAIL** [office@kekelit.com](mailto:office@kekelit.com)

[www.kekelit.com](http://www.kekelit.com)