

STEELOX

SMX450 ?STEELOX adapter with male thread 20x1/2"

57202D02

Areas of application

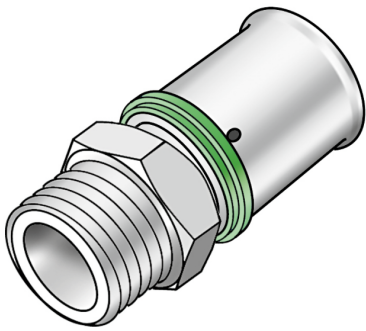

?Press-fit adapter with male thread for sealing, made of non-porous metallised dezincification-resistant (DZR) brass, incl. support sleeves with O-rings and stainless steel pressing sleeves, "leak before pressed"

Approvals:



KE KELIT GmbH

A 4020 Linz, Ignaz-Mayer-Straße 17, Austria, Europe

PHONE +43 (0) 50 779 E-MAIL office@kekelit.com

www.kekelit.com

Specifications

Article information

port 1	Pressing socket
port 2	Male thread, conical (NPT)
execution	1-part
design	Straight
press contour	SX

Technical properties

maximum working pressure at 20 ° C	10 bar
------------------------------------	--------

Product information

VPE1	10,00 SA1
VPE2	200,00 KT1
weight	0,074 KGM
text	?STEELOX adapter with male thread
INTRNR	74122000
code	SMX450

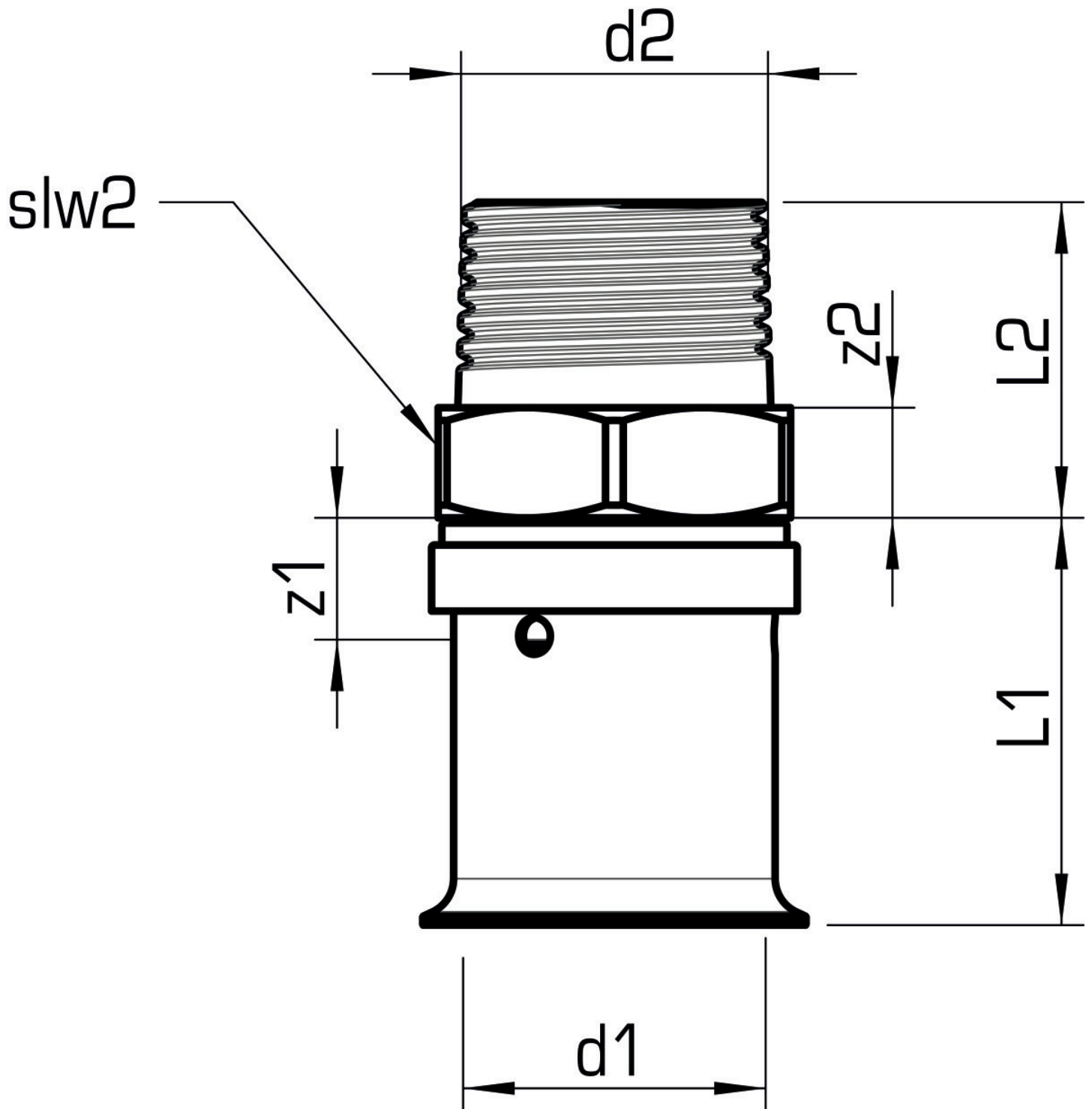

Art. No	label	d2 Inches	d1 mm	L1 mm	L2 mm	z1 mm	z2 mm	slw1	slw2 mm
57202D02	20x1/2"	1/2" (15)	20	30	22	5	4	24	24



KE KELIT GmbH

A 4020 Linz, Ignaz-Mayer-Straße 17, Austria, Europe

PHONE +43 (0) 50 779 **E-MAIL** office@kekelit.com

www.kekelit.com