

KELIT PEX

PEX35 KELIT PEX pre-insulated elbow 90° IS 2 75x6.8

3020262

Areas of application

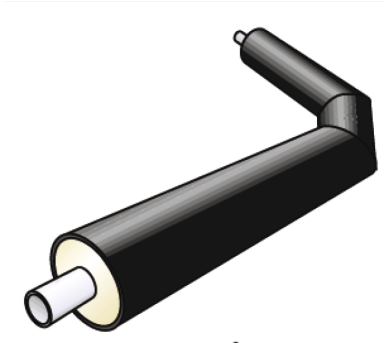

Pre-insulated PEX elbow, analogous to PEX00-2 WITHOUT medium and jacket pipe connection.

It may be necessary to use (PEX45) reducing sleeves to connect the pipe to the elbow!

Leg length: 1600 x 1100mm

Sizes d125 and d140mm on request!

Specifications

Product information	
casing DA	162
VPE1	1,00 STK
weight	9,000 KGM
text	KELIT PEX pre-insulated elbow 90° IS 2
INTRNR	39174000
main material group	KELIT PEX
material group	PEX fittings
code	PEX35

Art. No	label
3020262	75x6.8