

# KELIT PEX

## KELIT DUO-PEX pre-insulated ball valves 40+40

303950000034

### Areas of application

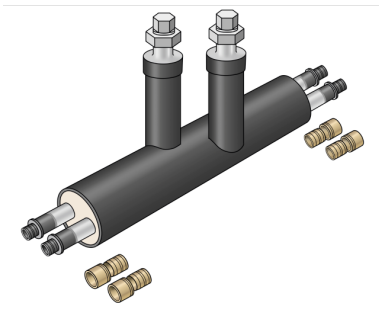

Pre-insulated, welded steel ball valves, INCLUDING 4 welded-on (PEX13) medium pipe connections, WITHOUT jacket pipe connections

You must use (PEX40 or PEX45) jacket pipe connection or reducing sleeves to connect the ball valve to the pipe or other shaped parts!

Overall length: 1500 x 500mm

ATTENTION: THESE ARE NOT EX-STOCK ITEMS!

# Specifications

## Product information

**text** KELIT DUO-PEX pre-insulated ball valves

## Art. No

303950000034

## label

40+40



**KE KELIT GmbH**

A 4020 Linz, Ignaz-Mayer-Straße 17, Austria, Europe

**PHONE** +43 (0) 50 779 **E-MAIL** [office@kekelit.com](mailto:office@kekelit.com)

[www.kekelit.com](http://www.kekelit.com)