

# KELIT PEX

## KELIT PEX pre-insulated ball valve 50

30395000006

### Areas of application

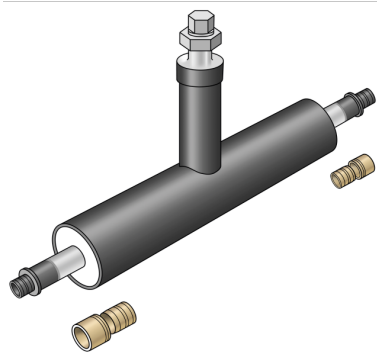

Pre-insulated, welded steel ball valve, INCLUDING 2 welded-on (PEX13) medium pipe connections, WITHOUT jacket pipe connections

You must use (PEX40 or PEX45) jacket pipe connection or reducing sleeves to connect the ball valve to the pipe or other shaped parts!

Overall length: 1500 x 500mm

Dimensions d125 and d140 mm on request!

ATTENTION: THESE ARE NOT EX-STOCK ITEMS!

# Specifications

## Product information

**text** KELIT PEX pre-insulated ball valve

## Art. No

## label

303950000006

50



**KE KELIT GmbH**

A 4020 Linz, Ignaz-Mayer-Straße 17, Austria, Europe

**PHONE** +43 (0) 50 779 **E-MAIL** [office@kekelit.com](mailto:office@kekelit.com)

[www.kekelit.com](http://www.kekelit.com)