

KELIT PEX

KELIT PEX pre-insulated ball valve 63

30395000008

Areas of application

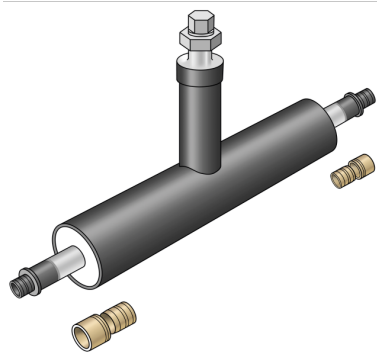

Pre-insulated, welded steel ball valve, INCLUDING 2 welded-on (PEX13) medium pipe connections, WITHOUT jacket pipe connections

You must use (PEX40 or PEX45) jacket pipe connection or reducing sleeves to connect the ball valve to the pipe or other shaped parts!

Overall length: 1500 x 500mm

Dimensions d125 and d140 mm on request!

ATTENTION: THESE ARE NOT EX-STOCK ITEMS!

Specifications

Product information

text KELIT PEX pre-insulated ball valve

Art. No

label

303950000008

63



KE KELIT GmbH

A 4020 Linz, Ignaz-Mayer-Straße 17, Austria, Europe

PHONE +43 (0) 50 779 **E-MAIL** office@kekelit.com

www.kekelit.com