

KELIT PEX

KELIT PEX pre-insulated tee piece SANITARY 40/20/32

3020495041

Areas of application

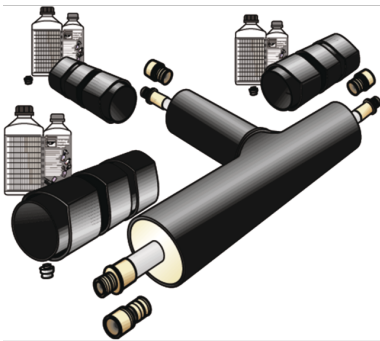

Pre-insulated, polypropylene (PP-R) T-piece straight, equal or reduced INCLUDING 3 medium pipe connections and 3 (PEX40 or PEX45) jacket pipe coupling sleeves

Overall length: 1000 x 500 mm

ATTENTION: THESE ARE NOT EX-STOCK ITEMS!

Specifications

Product information

text KELIT PEX pre-insulated tee piece SANITARY

Art. No

3020495041

label

40/20/32



KE KELIT GmbH

A 4020 Linz, Ignaz-Mayer-Straße 17, Austria, Europe

PHONE +43 (0) 50 779 **E-MAIL** office@kekelit.com

www.kekelit.com