

KELIT PEX

PEX11S-K KELIT PEX-PEX clamping connection SANITARY 32/32

30304310001SK

Areas of application

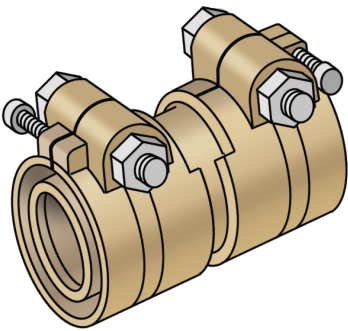

PEX / PEX clamping connection made of brass, for connecting PEX05 or PEX06 sanitary pipes
(SDR 7.4)

Specifications

Product information	
VPE1	1,00 STK
weight	0,500 KGM
text	KELIT PEX-PEX clamping connection SANITARY
INTRNR	74122000
main material group	KELIT PEX
material group	PEX sanitary-fittings
code	PEX11S-K

Art. No	label
30304310001SK	32/32