

KELIT PEX

PEX11S-K KELIT PEX-PEX clamping connection SANITARY 63/63

30304460001SK

Areas of application

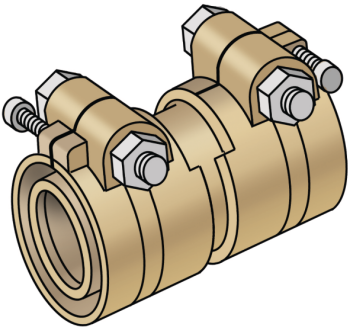

PEX / PEX clamping connection made of brass, for connecting PEX05 or PEX06 sanitary pipes (SDR 7.4)

Specifications

Product information	
VPE1	1,00 STK
weight	1,200 KGM
text	KELIT PEX-PEX clamping connection SANITARY
INTRNR	74122000
main material group	KELIT PEX
material group	PEX sanitary-fittings
code	PEX11S-K

Art. No	label
30304460001SK	63/63