

KELIT PEX

PEX15S-K KELIT PEX clamping connection with male thread SANITARY 63/2"

303017620

Areas of application

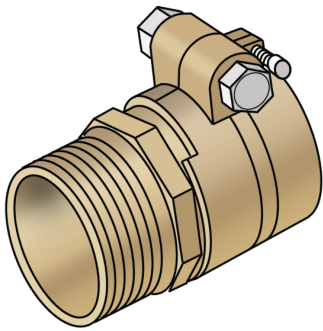

Steel/PEX clamping connection made of brass, adapter with male thread according to ÖNORM EN 10226 for connecting PEX05 or PEX06 pipes (SDR 7.4)

Specifications

Product information	
VPE1	1,00 STK
weight	1,150 KGM
text	KELIT PEX clamping connection with male thread SANITARY
INTRNR	74122000
main material group	KELIT PEX
material group	PEX sanitary-fittings
code	PEX15S-K

Art. No	label
303017620	63/2"