

KELIT PEX

PEX19S-K KELIT PEX tee piece clamping connection SANITARY 50/20/50

302090850001K

Areas of application

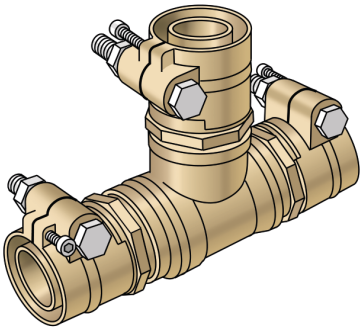

PEX tee clamping connection made of brass, for connecting PEX05 or PEX06 sanitary pipes (SDR 7.4)

Specifications

| Product information | |
|---------------------|--|
| VPE1 | 1,00 STK |
| weight | 2,200 KGM |
| text | KELIT PEX tee piece clamping connection SANITARY |
| INTRNR | 74122000 |
| main material group | KELIT PEX |
| material group | PEX sanitary-fittings |
| code | PEX19S-K |

| Art. No | label |
|---------------|----------|
| 302090850001K | 50/20/50 |