

# KELIT PEX

## PEX19S-K KELIT PEX tee piece clamping connection SANITARY 63/25/63

302091450001K

### Areas of application

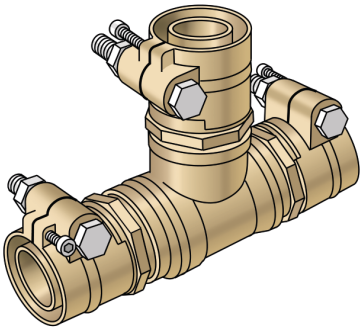

PEX tee clamping connection made of brass, for connecting PEX05 or PEX06 sanitary pipes (SDR 7.4)

# Specifications

Product information	
VPE1	1,00 STK
weight	3,900 KGM
text	KELIT PEX tee piece clamping connection SANITARY
INTRNR	74122000
main material group	KELIT PEX
material group	PEX sanitary-fittings
code	PEX19S-K

Art. No	label
302091450001K	63/25/63