

KELIT PEX

PEX11-K KELIT PEX-PEX clamping connection 32x2.9/32x2.9

303043100010

Areas of application

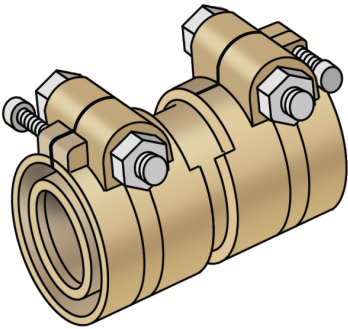

PEX / PEX clamping connection made of brass, for connecting PEX00, PEX03, PEX09 or PEX10 pipes (SDR 11)

Specifications

Product information	
VPE1	1,00 STK
weight	0,500 KGM
text	KELIT PEX-PEX clamping connection
INTRNR	74122000
main material group	KELIT PEX
material group	PEX fittings and accessories
code	PEX11-K

Art. No	label
303043100010	32x2.9/32x2.9