

# KELIT PEX

## PEX11-K KELIT PEX-PEX clamping connection 50x4.6/50x4.6

303044100010

### Areas of application

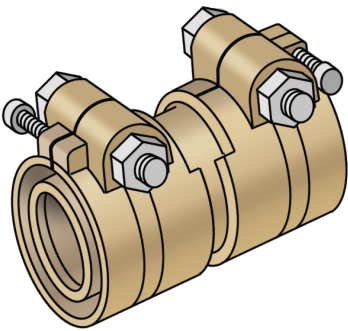

PEX / PEX clamping connection made of brass, for connecting PEX00, PEX03, PEX09 or PEX10 pipes (SDR 11)

# Specifications

Product information	
VPE1	1,00 STK
weight	1,150 KGM
text	KELIT PEX-PEX clamping connection
INTRNR	74122000
main material group	KELIT PEX
material group	PEX fittings and accessories
code	PEX11-K

Art. No	label
303044100010	50x4.6/50x4.6