

# KELIT PEX

## PEX11-K KELIT PEX-PEX clamping connection 75x6.8/75x6.8

303045100010

### Areas of application

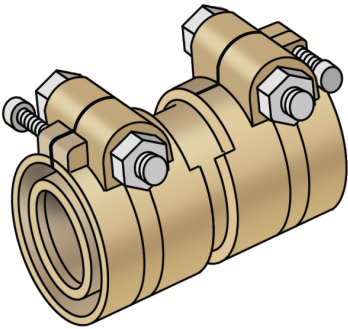

PEX / PEX clamping connection made of brass, for connecting PEX00, PEX03, PEX09 or PEX10 pipes (SDR 11)

# Specifications

Product information	
VPE1	1,00 STK
weight	2,000 KGM
text	KELIT PEX-PEX clamping connection
INTRNR	74122000
main material group	KELIT PEX
material group	PEX fittings and accessories
code	PEX11-K

Art. No	label
303045100010	75x6.8/75x6.8