

KELIT PEX

PEX13-K KELIT PEX clamping connection with welding socket piece 125x11.4/DN100

303022100010

Areas of application

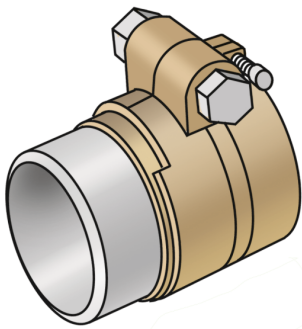

Steel/PEX press connection adapter with ST 37.0 welding socket piece for connecting PEX00, PEX03, PEX09 or PEX10 pipes (SDR 11)

Specifications

Product information	
VPE1	1,00 STK
weight	5,800 KGM
text	KELIT PEX clamping connection with welding socket piece
INTRNR	74122000
main material group	KELIT PEX
material group	PEX fittings and accessories
code	PEX13-K

Art. No	label
303022100010	125x11.4/DN100