

# KELIT PEX

## PEX61 KELIT DUO-PEX end cap heat shrink 63+63

3031350

### Areas of application

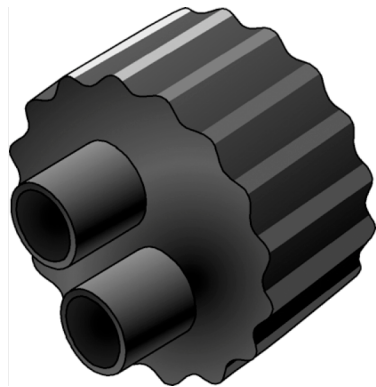

PE-HD heat shrinking DUO end cap, for watertight insulating seals in ducts or buildings

# Specifications

Product information	
<b>casing DA</b>	182-202
<b>VPE1</b>	1,00 STK
<b>weight</b>	0,230 KGM
<b>text</b>	KELIT DUO-PEX end cap heat shrink
<b>INTRNR</b>	39174000
<b>main material group</b>	KELIT PEX
<b>material group</b>	PEX sleeves and accessories
<b>code</b>	PEX61

Art. No	label
3031350	63+63