

KELIT PEX

KELIT QUATTRO-PEX end cap heat shrink 2x40/40+25

3031412

Areas of application

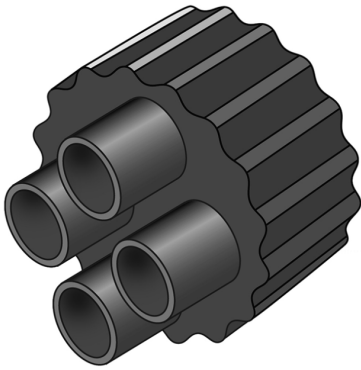

QUATTRO heat shrinking end cap made from PE-HD, for watertight insulating seals in ducts or buildings

Specifications

Product information

text KELIT QUATTRO-PEX end cap heat shrink

Art. No

3031412

label

2x40/40+25



KE KELIT GmbH

A 4020 Linz, Ignaz-Mayer-Straße 17, Austria, Europe

PHONE +43 (0) 50 779 **E-MAIL** office@kekelit.com

www.kekelit.com