

KELOX_{FB}

KM683 KELOX dry wooden frame 250x44x30mm

6103620

Areas of application

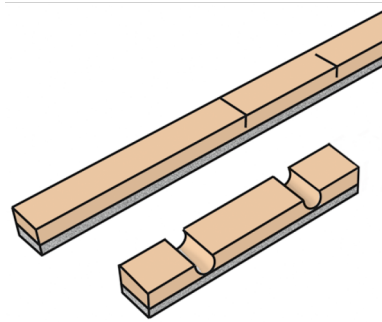

Wooden frame placed loosely all round to improve the compressive strength of the floor. To allow you to provide the necessary stability when changing floor coverings and to fasten the top profile rail, the wooden frame must be screwed in place at the doorways.

Two-layer structure, MDF 22 GL (22 mm medium-density fibreboard) as the base and pressure-stable low-density fibreboard WF 08 Hopa - 8mm

Wooden frame L: 1000mm W: 44mm H: 30mm

Passage wood L: 250mm W: 44mm H: 30mm - incl. 2 pipe grooves

Specifications

Product information	
VPE1	1,00 KT1
VPE2	10,00 KT2
weight	0,100 KGM
text	KELOX dry wooden frame
INTRNR	44187900
code	KM683

Art. No	label
6103620	250x44x30mm