

KELIT PEX

PEX30S KELIT PEX Vorisoliertes T-Stück SANITÄR 50/32/50

3020495070

Areas of application

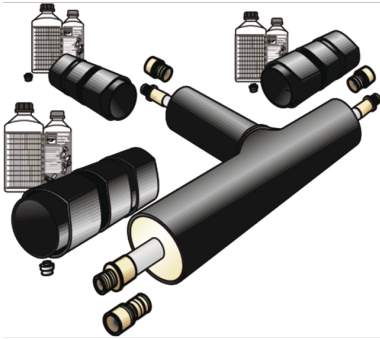

Vorisoliertes, Polypropylen (PP-R) T-Stück gerade, egal oder reduziert, INKLUSIVE 3
Mediumrohrverbindungen und 3 Mantelrohrverbindungsmuffen (PEX40 oder PEX45)

Baulänge: 1000 x 500mm

ACHTUNG: KEINE LAGERWARE!

Specifications

Product information	
casing DA	111/76/111
VPE1	1,00 STK
weight	10,400 KGM
text	KELIT PEX Vorisoliertes T-Stück SANITÄR
INTRNR	39174000
main material group	KELIT PEX
material group	PEX Sanitär-Formstücke
code	PEX30S



KE KELIT GmbH

A 4020 Linz, Ignaz-Mayer-Straße 17, Austria, Europe

PHONE +43 (0) 50 779 **E-MAIL** office@kekelit.com

www.kekelit.com