

# KELIT PEX

## PEX30S KELIT PEX Vorisoliertes T-Stück SANITÄR 63/40/50

3020495092

### Areas of application

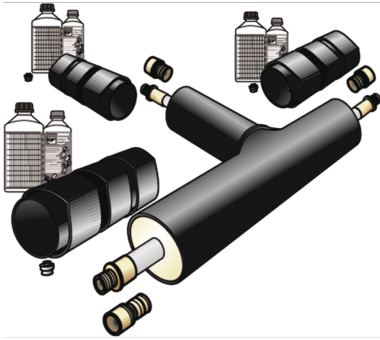

Vorisoliertes, Polypropylen (PP-R) T-Stück gerade, egal oder reduziert, INKLUSIVE 3  
Mediumrohrverbindungen und 3 Mantelrohrverbindungsmuffen (PEX40 oder PEX45)

Baulänge: 1000 x 500mm

**ACHTUNG: KEINE LAGERWARE!**

# Specifications

Product information	
<b>casing DA</b>	126/91/111
<b>VPE1</b>	1,00 STK
<b>weight</b>	11,650 KGM
<b>text</b>	KELIT PEX Vorisoliertes T-Stück SANITÄR
<b>INTRNR</b>	39174000
<b>main material group</b>	KELIT PEX
<b>material group</b>	PEX Sanitär-Formstücke
<b>code</b>	PEX30S



**KE KELIT GmbH**

A 4020 Linz, Ignaz-Mayer-Straße 17, Austria, Europe

**PHONE** +43 (0) 50 779 **E-MAIL** [office@kekelit.com](mailto:office@kekelit.com)

[www.kekelit.com](http://www.kekelit.com)