

KELIT PEX

PEX19S-K KELIT PEX tee piece clamping connection SANITARY 40/25/50

302090530001K

Areas of application

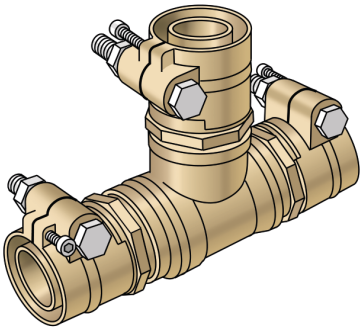

PEX tee clamping connection made of brass, for connecting PEX05 or PEX06 sanitary pipes (SDR 7.4)

Specifications

Product information	
VPE1	1,00 STK
weight	2,000 KGM
text	KELIT PEX tee piece clamping connection SANITARY
INTRNR	74122000
main material group	KELIT PEX
material group	PEX sanitary-fittings
code	PEX19S-K

Art. No	label
302090530001K	40/25/50