

# KE1008 KELEN-PP-RCT CX pipe - PN16 25x3.5

30025005

## Areas of application

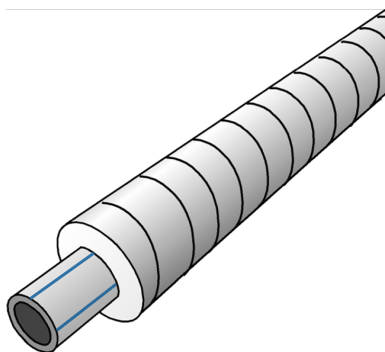

Pre-insulated drinking water pipe system based on ÖNORM EN ISO 15874

Medium pipe: KELEN made of polypropylene copolymer (PP-R), adhesion-pretreated

Application area: 20°C/16 bar - 60°C/8 bar

Insulation: PUR rigid foam

Jacket pipe: 0.6 mm galvanised folded spiral sheet metal

Length: 6m

## Approvals:



# Specifications

Product information	
<b>casing DA</b>	80
<b>VPE1</b>	6,00 STG
<b>L</b>	6 m
<b>weight</b>	1,980 KGM
<b>text</b>	KELEN-PP-RCT CX pipe - PN16
<b>INTRNR</b>	39172290
<b>main material group</b>	KELEN CX/PE
<b>material group</b>	KELEN CX/PE pipes and fittings
<b>code</b>	KE1008

Art. No	label
30025005	25x3.5