

CF1000 STEELFIX-CX carbon steel pipe 28x1.5

3000115

Areas of application

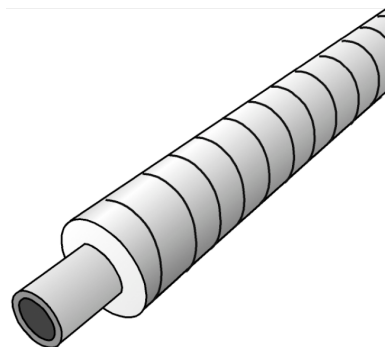

Pre-insulated carbon steel piping system

Medium pipe: Thin-walled, longitudinally welded stainless steel pipes according to EN 10305-3 with a particularly low carbon content and with the outside protected by a thermally applied zinc layer and a passivating/chromium layer

Area of application: closed heating and cooling circuits

Operating temperature: - 35°C to 120°C/16 bar - tmax 150°C - short-term

Insulation: PUR rigid foam, jacket pipe: 0.6 mm galvanised folded spiral sheet metal

Length: 6m

Specifications

Product information	
casing DA	80
VPE1	6,00 STG
L	6 m
weight	2,730 KGM
text	STEELFIX-CX carbon steel pipe
INTRNR	73065080
main material group	STEELFIX CX/PE
material group	STEELFIX CX/PE C-Stahl pipes and fittings
code	CF1000

Art. No	label
3000115	28x1.5