

NF2000 STEELFIX-PE stainless steel pipe 1.4401 54x1.5

3000380

Areas of application

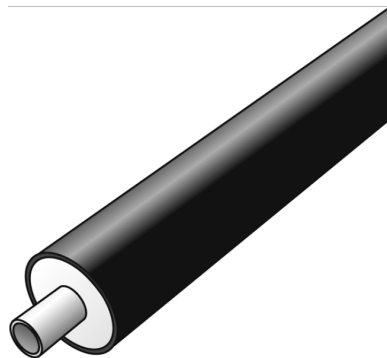

Pre-insulated stainless steel piping system

Medium pipe: Thin-walled, longitudinally welded stainless steel pipes 1.4401 according to EN 10312 and EN 10217-7 outside and inside bare metallic

Application area: Drinking water installations, service water and rain water, compressed air

Operating temperature: - 35°C to 120°C/16 bar - tmax 150°C - short-term

Insulation: PUR hard foam, jacket pipe: PE-HD

Length: 6m

Approvals:



KE KELIT GmbH

A 4020 Linz, Ignaz-Mayer-Straße 17, Austria, Europe

PHONE +43 (0) 50 779 E-MAIL office@kekelit.com

www.kekelit.com

Specifications

Article information

port 1 Pipe end

Technical properties

pipe weight 4,88 kg/m

pipe contents 2,042 l/m

PN PN 16

Product information

casing DA 125

VPE1 6,00 STG

L 6 m

weight 3,770 KGM

text STEELFIX-PE stainless steel pipe 1.4401

INTRNR 73064080

main material group STEELFIX CX/PE

material group STEELFIX CX/PE stainless steel pipes and fittings

code NF2000

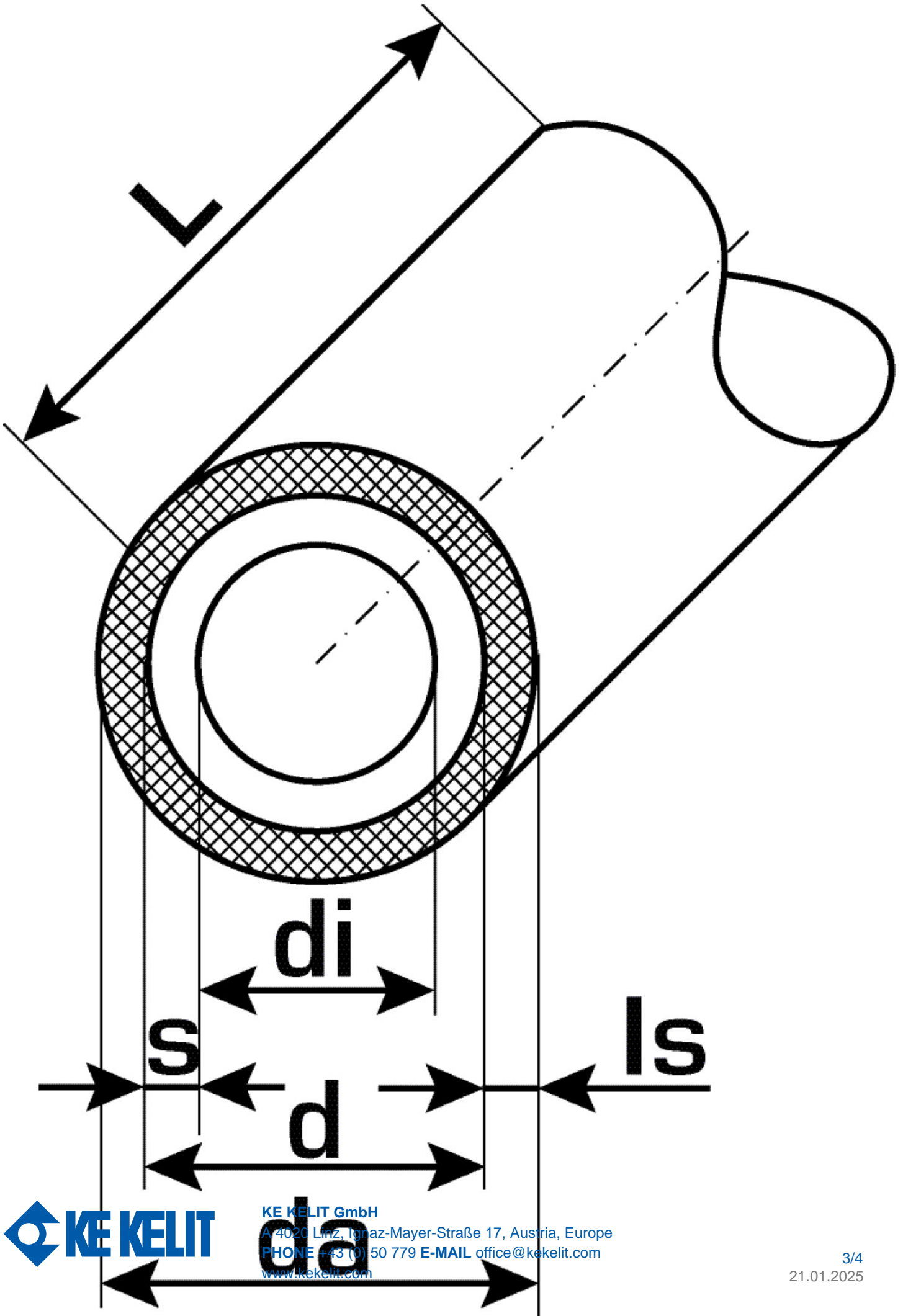

Art. No	label	d	d1 mm	pipe contents l/m	s mm
3000380	54x1.5	51	54	2,042	1,5



KE KELIT GmbH

A 4020 Linz, Ignaz-Mayer-Straße 17, Austria, Europe

PHONE +43 (0) 50 779 **E-MAIL** office@kekelit.com

www.kekelit.com