

# NP2020 STEELFIX-PE stainless steel elbow 1.4401 35x1.5

3000670

## Areas of application

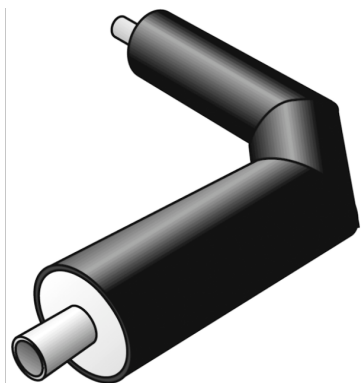

Pre-insulated stainless steel 90° elbow

Medium pipe: Thin-walled, longitudinally welded stainless steel pipes 1.4401 according to EN 10312 and EN 10217-7 outside and inside bare metallic

Application area: Drinking water installations, service water and rain water, compressed air

Insulation: PUR hard foam, jacket pipe: PE-HD

also available in 45°!

Leg length: 500 x 500mm, other leg lengths on request!

## Approvals:



# Specifications

Product information	
<b>casing DA</b>	90
<b>VPE1</b>	1,00 STK
<b>weight</b>	2,390 KGM
<b>text</b>	STEELFIX-PE stainless steel elbow 1.4401
<b>INTRNR</b>	73071990
<b>main material group</b>	STEELFIX CX/PE
<b>material group</b>	STEELFIX CX/PE stainless steel pipes and fittings
<b>code</b>	NP2020

Art. No	label
3000670	35x1.5