

# STEEL FIX EDELSTAHL

NP447 STEELFIX stainless steel press-fit-tee  
with branch female 54x2"

53740H09

## Areas of application

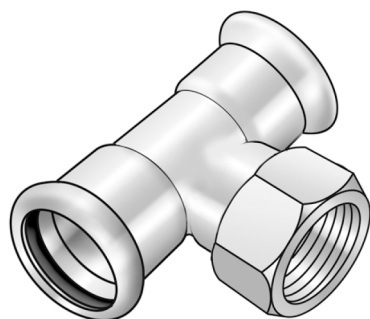

Press-tee with threaded branch female made of stainless steel 1.4404, incl. EPDM sealing elements,  
d15-54 "leak before pressed"

Press contour: M

## Approvals:



# Specifications

## Article information

port 1	Pressmuffe
port 2	Innengewinde konisch (NPT)
port 3	Pressmuffe
execution	T-Stück
press contour	M

## Technical properties

maximum working pressure at 20 ° C	16 bar
------------------------------------	--------

## Product information

VPE1	2,00 SA1
VPE2	6,00 KT1
VPE3	150,00 DDP
weight	0,673 KGM
text	STEELFIX stainless steel press-fit-tee with branch female
INTRNR	73072980
material group	EDELSTAHL pressfittings
code	NP447



Art. No	label	d2 Inches	d1 mm	d3 mm	L1 mm	L2 mm	L3 mm	z1 mm	z2 mm	z3 mm	slw1 mm
53740H0	54x2"	2"	54	54	71	65	71	36	47	36	38