

STEEL FIX EDELSTAHL

NPI450 STEELFIX industrial stainless steel press-fit adapter with male thread 22x3/4"

53802D04

Areas of application



Press-adapter with male thread conforming to EN 10226-1 made of stainless steel 1.4301, incl. EPDM sealing elements, d15-54 "leak before pressed"

Press contour: M

ATTENTION: NOT suitable for drinking water!

Specifications

Article information

port 1	Pressmuffe
port 2	Außengewinde konisch BSPT-R (ISO 7-1 / EN 10226-1)
execution	1-teilig
design	gerade
press contour	M

Product information

VPE1	10,00 SA1
VPE2	80,00 KT1
VPE3	2000,00 PAL
weight	0,080 KGM
text	STEELFIX industrial stainless steel press-fit adapter with male thread
INTRNR	73072980
code	NPI450

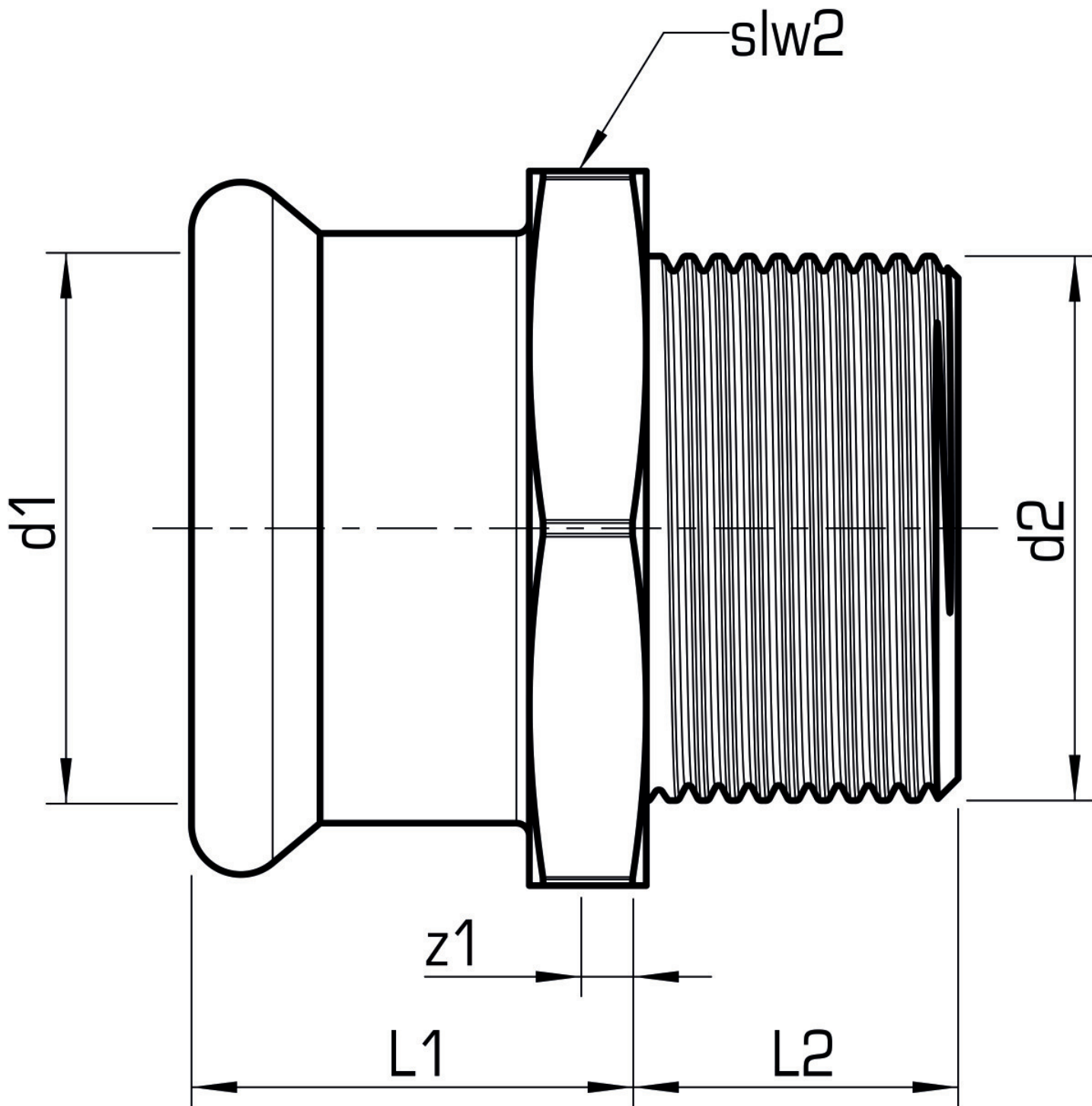

Art. No	label	d2 Zoll	d1 mm	L1 mm	L2 mm	z1 mm	slw2 mm
53802D04	22x3/4"	3/4 Zoll (20)	22	25	19	4	32