

STEEL FIX EDELSTAHL

NPI457 STEELFIX industrial stainless steel press-fit adapter with female thread 18x1/2"

53806C02

Areas of application

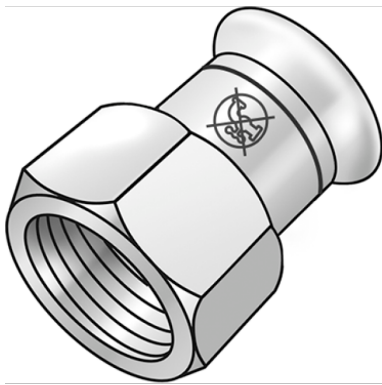

Press-adapter with female thread made of stainless steel 1.4301, incl. EPDM sealing elements, d15-54 "leak before pressed"

Press contour: M

ATTENTION: NOT suitable for drinking water!

Specifications

Article information

port 1	Pressmuffe
port 2	Innengewinde zylindrisch BSPT-Rp (ISO 7-1 / EN 10226-1)
execution	1-teilig
design	gerade
press contour	M

Product information

VPE1	10,00 SA1
VPE2	100,00 KT1
VPE3	2500,00 PAL
weight	0,070 KGM
text	STEELFIX industrial stainless steel press-fit adapter with female thread
INTRNR	73072980
code	NPI457



Art. No	label	d2 Zoll	d1 mm	L1 mm	L2 mm	z1 mm	z2 mm	slw2 mm
53806C02	18x1/2"	1/2 Zoll (15)	18	22	15	2	5	27



KE KELIT GmbH

A 4020 Linz, Ignaz-Mayer-Straße 17, Austria, Europe

PHONE +43 (0) 50 779 **E-MAIL** office@kekelit.com

www.kekelit.com