

KELEN

KE06 KELEN ALU-composite pipe - PN20 50x6.9

1655001

Areas of application

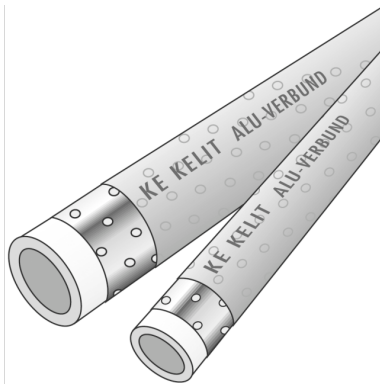

KELEN ALU - composite pipe conforming to ÖNORM EN ISO 15874, made of polypropylene copolymer (PP-R), mechanically stabilising aluminium pipe attached to the outer wall of the medium pipe with a bonding agent and protective layer

Application area: 20°C/20 bar - 70°C/8 bar

Colour: medium pipe is of natural colour, protection layer is grey

Length: 4m

Approvals:



Specifications

Article information

color blau

trade length 4 m

Technical properties

maximum working pressure at 20 ° C 20 bar

pipe weight 1,03 kg/m

pipe contents 1,03 l/m

lambda pipe 0,24 W/(m.K)

wall rawness 0,007 mm

expansion coefficient 0,035 mm/(m.K)

Product information

DIM2 36,2

VPE1 20,00 BND

L 4 m

weight 1,030 KGM

text KELEN ALU-composite pipe - PN20

INTRNR 39172290

main material group KELEN

material group KELEN pipes

code KE06



Art. No	label	d1 mm	pipe contents l/m	s mm
1655001	50x6.9	50	1,03	6,9



KE KELIT GmbH

A 4020 Linz, Ignaz-Mayer-Straße 17, Austria, Europe

PHONE +43 (0) 50 779 **E-MAIL** office@kekelit.com

www.kekelit.com