

# KELEN

## KE13 KELEN PP-RCT adapter female 50x6/4"S

2589501

### Areas of application



KELEN PP-RCT Polyfusion welding fitting for connecting pipes with fittings made of the same material (no reduction of internal diameter), with injected male thread made of dezincification-resistant brass, non-porous metal plating, threads conform to ÖNORM EN 10226

System parts marked with an "S" are produced with a wrench attachment connection

Do NOT connect to threaded pipes or to cast iron fittings!

### Approvals:



KE KELIT GmbH

A 4020 Linz, Ignaz-Mayer-Straße 17, Austria, Europe

PHONE +43 (0) 50 779 E-MAIL [office@kekelit.com](mailto:office@kekelit.com)

[www.kekelit.com](http://www.kekelit.com)

# Specifications

## Article information

port 1	Kunststoffschweißmuffe
port 2	Innengewinde zylindrisch BSPT-Rp (ISO 7-1 / EN 10226-1)
design	gerade

## Product information

VPE1	2,00 SA1
VPE2	16,00 KT1
VPE3	64,00 KT2
VPE4	1536,00 PAL
weight	0,446 KGM
text	KELEN PP-RCT adapter female
INTRNR	39174000
main material group	KELEN
material group	KELEN metal fittings
code	KE13

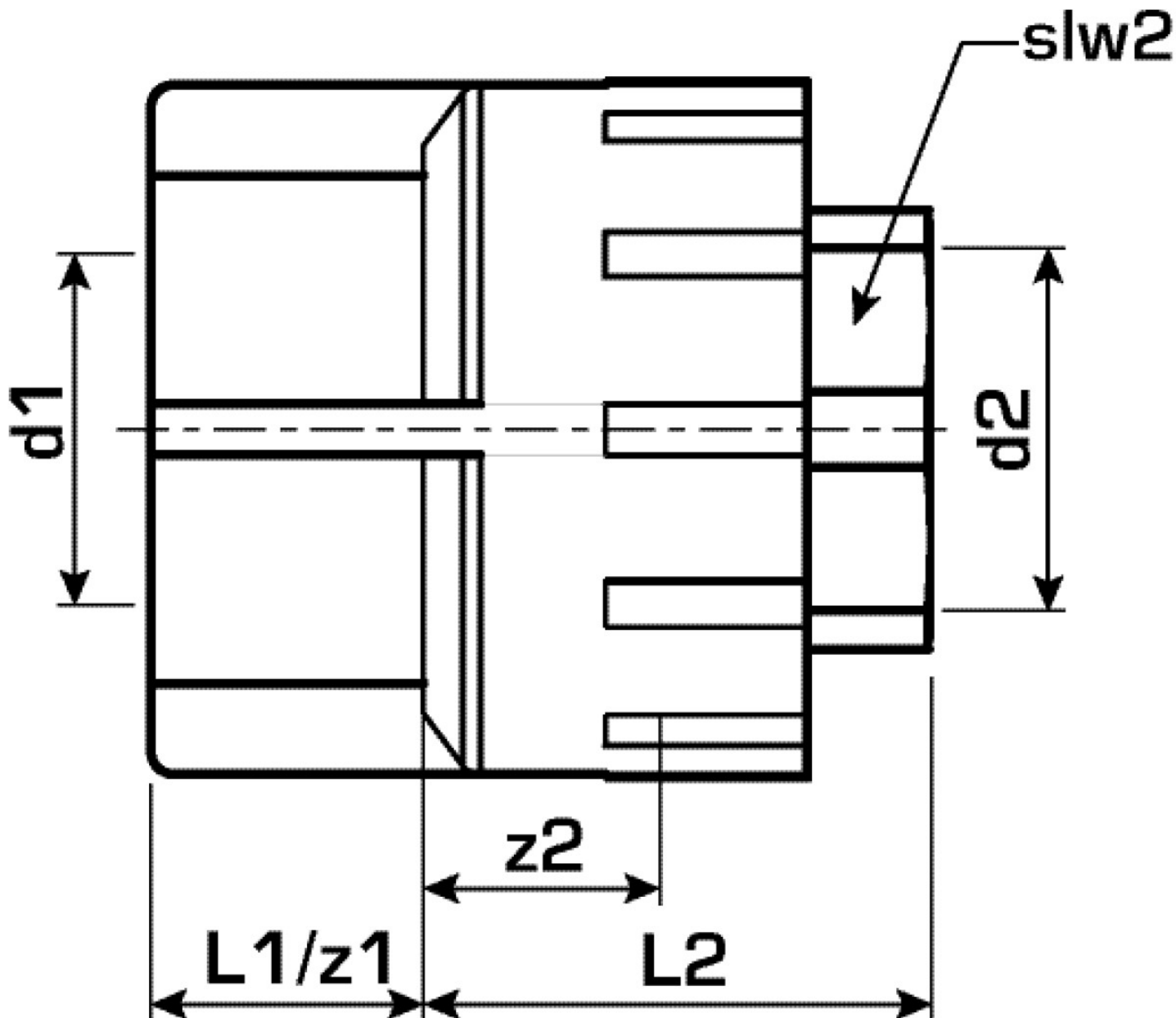

Art. No	label	d2	d1 mm	L1 mm	L2 mm	z1 mm	z2 mm	slw2
2589501	50x6/4"S	1 1/2"	50	27	44	27	29	56