

KELEN

K95 KELIT stopper 1/2" M

2803120

Areas of application

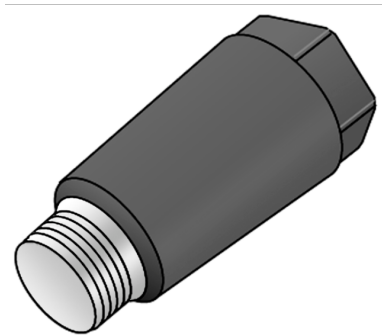

KELIT plastic stopper made of plastic with brass thread to securely seal wall outlets, flat sealing incl.

EPDM seal

Colour: black

Approvals:



KE KELIT GmbH

A 4020 Linz, Ignaz-Mayer-Straße 17, Austria, Europe

PHONE +43 (0) 50 779 E-MAIL office@kekelit.com

www.kekelit.com

Specifications

Technical properties

suitable for pipe diameter 12,7 mm

Product information

VPE1 10,00 SA1

VPE2 80,00 KT1

VPE3 480,00 KT2

VPE4 7680,00 PAL

weight 0,052 KGM

text KELIT stopper

INTRNR 39174000

main material group KELEN

material group KELEN accessories

code K95

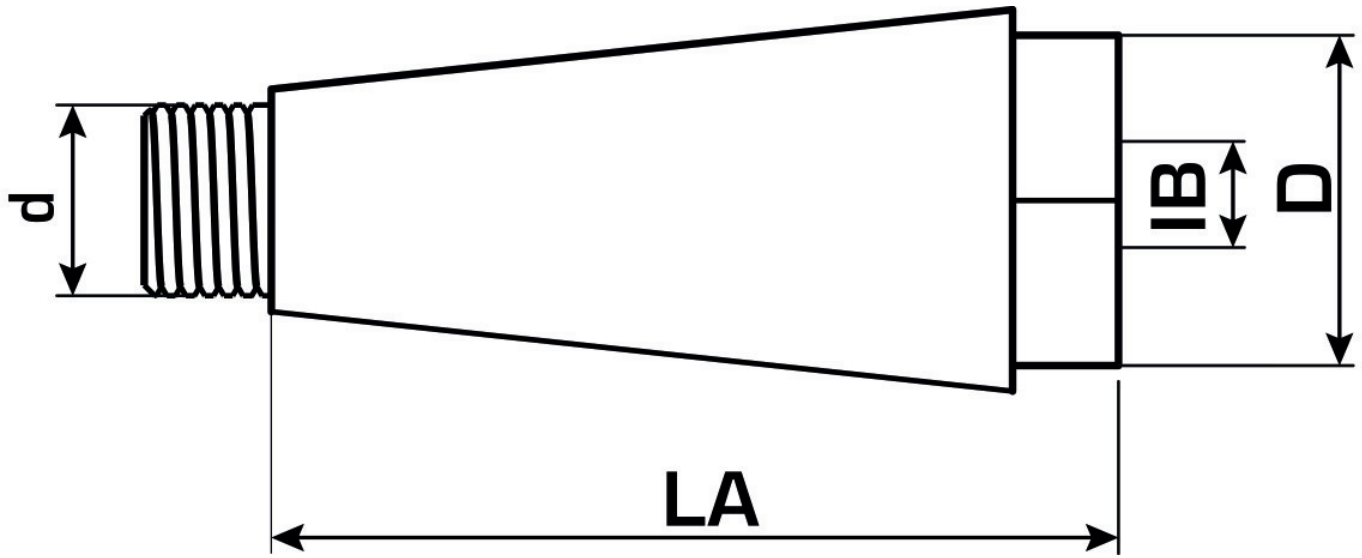

Art. No	label	d mm	d1 mm
2803120	1/2" M	12	36