

KELOX

KM111 KELOX multilayer pipe nipple 32x3

74103201

Areas of application

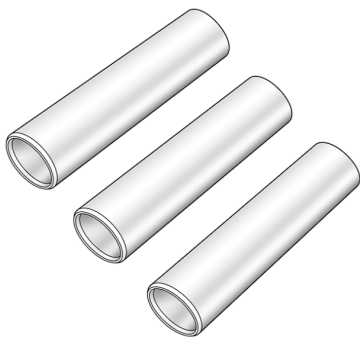

KELOX multilayer pipe nipple made of PE-RT/Al/PE-RT, calibrated on both sides to the shortest connection between two mouldings

Length:

d16 and 20mm - 71mm

d25 and 32mm - 83mm

Approvals:



KE KELIT GmbH

A 4020 Linz, Ignaz-Mayer-Straße 17, Austria, Europe

PHONE +43 (0) 50 779 E-MAIL office@kekelit.com

www.kekelit.com

Specifications

Article information

color White

flexible 1

Technical properties

maximum working pressure at 20 ° C 10 bar

pipe contents 0,531 l/m

lambda pipe 0,45 W/(m.K)

wall rawness 0,007 mm

expansion coefficient 0,025 mm/(m.K)

Product information

VPE1 10,00 SA1

VPE2 80,00 KT1

weight 0,033 KGM

text KELOX multilayer pipe nipple

INTRNR 39173900

main material group KELOX

material group KELOX pipes

code KM111

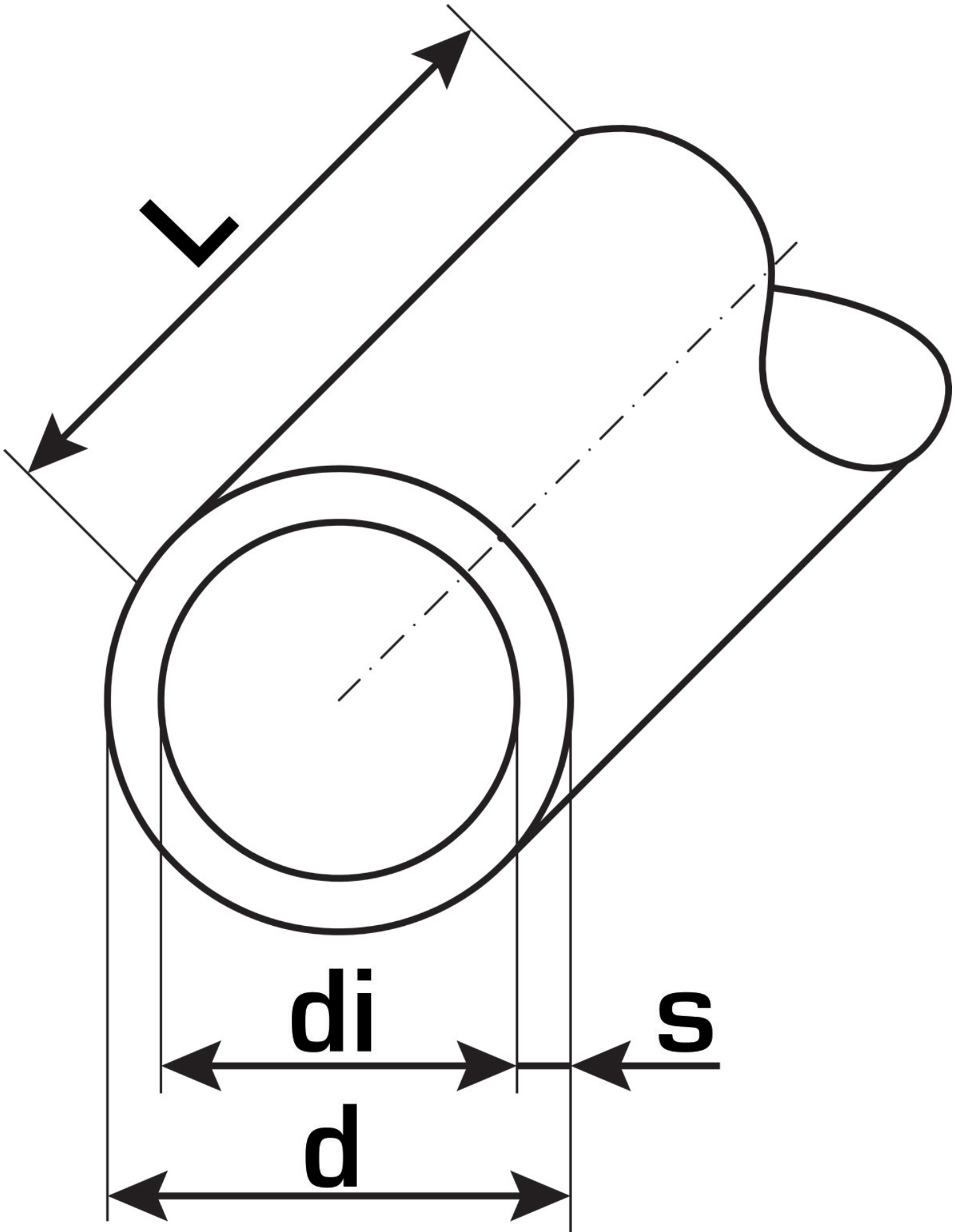

Art. No	label	d1 mm	pipe contents l/m	s mm
74103201	32x3	32	0,531	3



KE KELIT GmbH

A 4020 Linz, Ignaz-Mayer-Straße 17, Austria, Europe

PHONE +43 (0) 50 779 **E-MAIL** office@kekelit.com

www.kekelit.com