

KELOX

KMU447 KELOX-ULTRAX adapter tee female 25x3/4"

71240E04

Areas of application

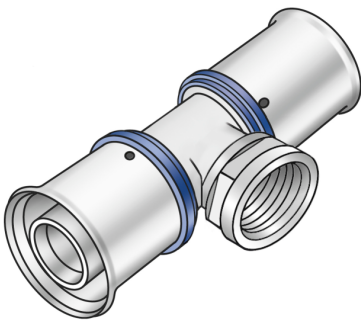

Press tee with female thread adapter, made of non-porous metallised brass; including support sleeves with O-rings and stainless steel press-fit sleeves; "leak before pressed"
DO NOT screw in any threaded pipes and cast iron fittings!

Approvals:



Specifications

Article information

port 1	Pressing socket
port 2	Female thread
port 3	Pressing socket
execution	Tee piece
angle	90 °
press contour	U

Technical properties

maximum working pressure at 20 ° C	16 bar
------------------------------------	--------

Product information

VPE1	4,00 SA1
VPE2	44,00 KT1
weight	0,231 KGM
text	KELOX-ULTRAX adapter tee female
INTRNR	74122000
main material group	KELOX
material group	KELOX-ULTRAX metal fittings
code	KMU447

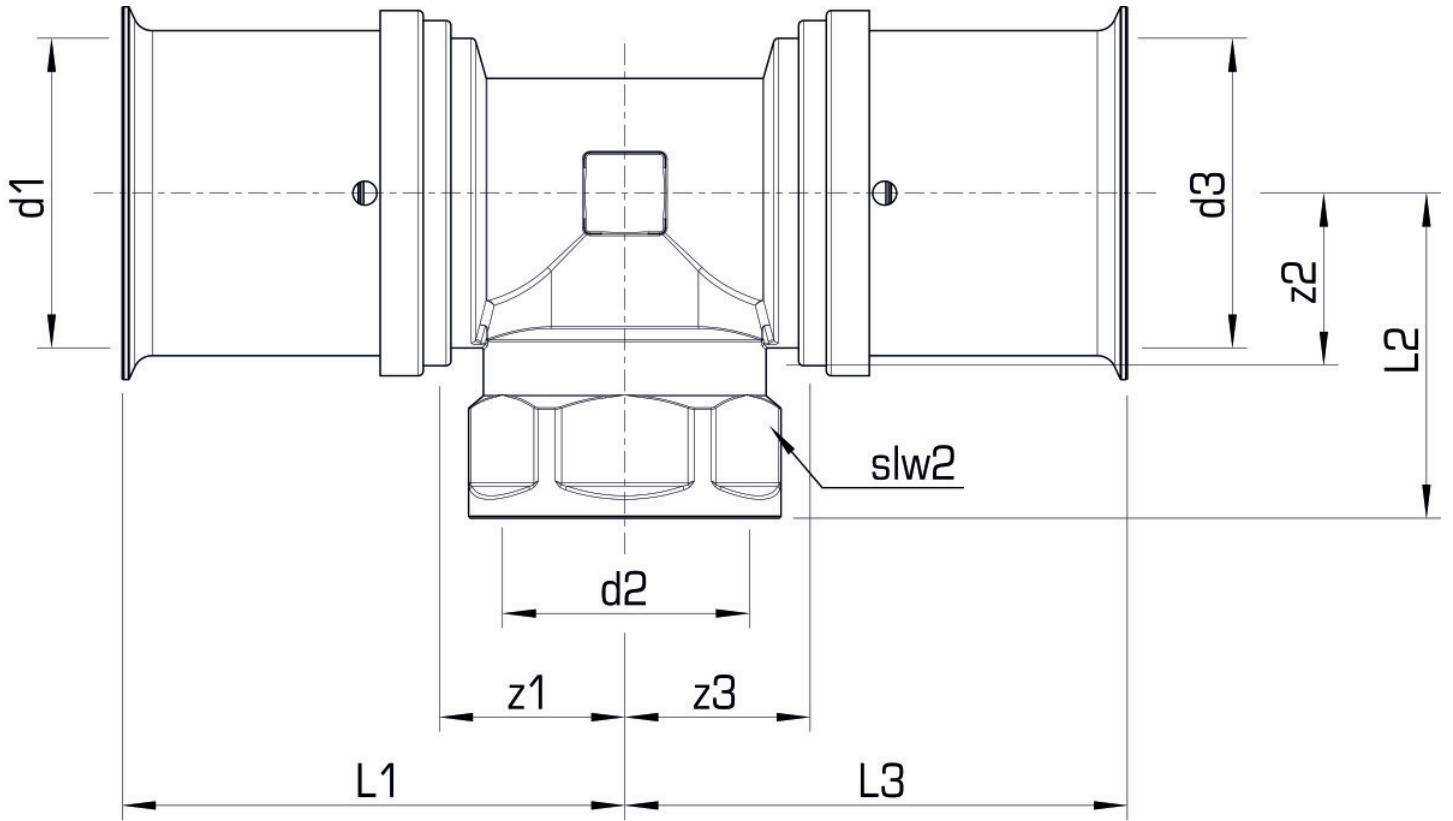

Art. No	label	d2 Inches	d1 mm	d3 mm	L1 mm	L2 mm	L3 mm	z1 mm	z2 mm	z3 mm	slw1 mm
71240E0	25x3/4"	3/4" (20)	25	25	63	34	63	19	19	19	30