

KELOX

KMU451 KELOX-ULTRAX union with male thread 20x3/4"

71241D04

Areas of application

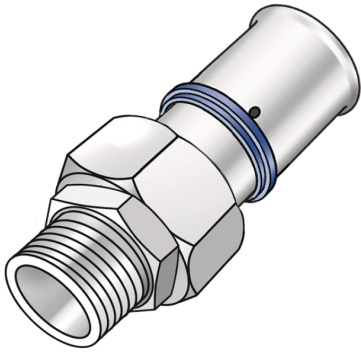

ULTRAX press-fit union with male thread made from stainless steel, thread as per ÖNORM EN 10226, for connecting to fittings made of non-porous metallised brass; incl. support sleeves with O-rings and stainless steel press-fit sleeves "leak before pressed", flat-sealing including seal

Approvals:



Specifications

Article information

port 1	Pressmuffe
port 2	Außengewinde konisch (NPT)
execution	2-part
design	Straight
press contour	U

Technical properties

maximum working pressure at 20 ° C	10 bar
------------------------------------	--------

Product information

VPE1	10,00 SA1
VPE2	100,00 KT1
weight	0,144 KGM
text	KELOX-ULTRAX union with male thread
INTRNR	74122000
main material group	KELOX
material group	KELOX-ULTRAX metal fittings
code	KMU451



Art. No	label	d2 Inches	d1 mm	L1 mm	L2 mm	z1 mm	z2 mm	slw1 mm	slw2 mm
71241D04	20x3/4"	3/4" (20)	20	42	17	17,5	34	30	32