

KELOX

KMU455 KELOX-ULTRAX union with female thread 16x1/2"

71203B02

Areas of application

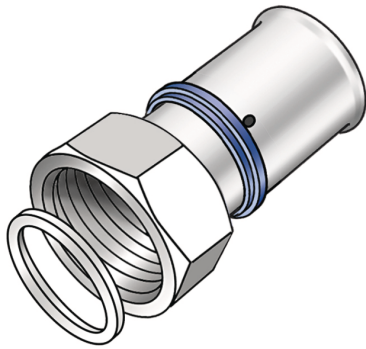

?Press-fit union with female thread for connection to fittings and devices such as filters, manifolds, pumps,..... made of non-porous metallised brass, incl. support sleeves with O-rings and stainless steel pressing sleeves, "leak before pressed", flat-sealing including seal

Approvals:



Specifications

Article information

port 1	Pressing socket
port 2	Union nut
execution	2-part
design	Straight
press contour	U

Technical properties

maximum working pressure at 20 ° C	10 bar
------------------------------------	--------

Product information

VPE1	10,00 SA1
VPE2	200,00 KT1
weight	0,058 KGM
text	KELOX-ULTRAX union with female thread
INTRNR	74122000
main material group	KELOX
material group	KELOX-ULTRAX metal fittings
code	KMU455



Art. No	label	d2 Inches	d1 mm	L1 mm	L2 mm	z1 mm	slw2 mm
71203B02	16x1/2"	1/2" (15)	16	38,5	8,5	16	24