

KELOX

KMU467 KELOX-ULTRAX elbow adapter 90° female 20x1/2"

71216D02

Areas of application



Press elbow adapter with female thread, made of non-porous metallised brass; including support sleeves with O-rings and stainless steel press-fit sleeves; "leak before pressed"
DO NOT screw in any threaded pipes and cast iron fittings!

Approvals:



KE KELIT GmbH

A 4020 Linz, Ignaz-Mayer-Straße 17, Austria, Europe

PHONE +43 (0) 50 779 E-MAIL office@kekelit.com

www.kekelit.com

Specifications

Article information

port 1	Pressing socket
execution	1-part
design	Knee
angle	90 °
press contour	U

Technical properties

maximum working pressure at 20 ° C	10 bar
------------------------------------	--------

Product information

VPE1	10,00 SA1
VPE2	160,00 KT1
weight	0,088 KGM
text	KELOX-ULTRAX elbow adapter 90° female
INTRNR	74122000
main material group	KELOX
material group	KELOX-ULTRAX metal fittings
code	KMU467

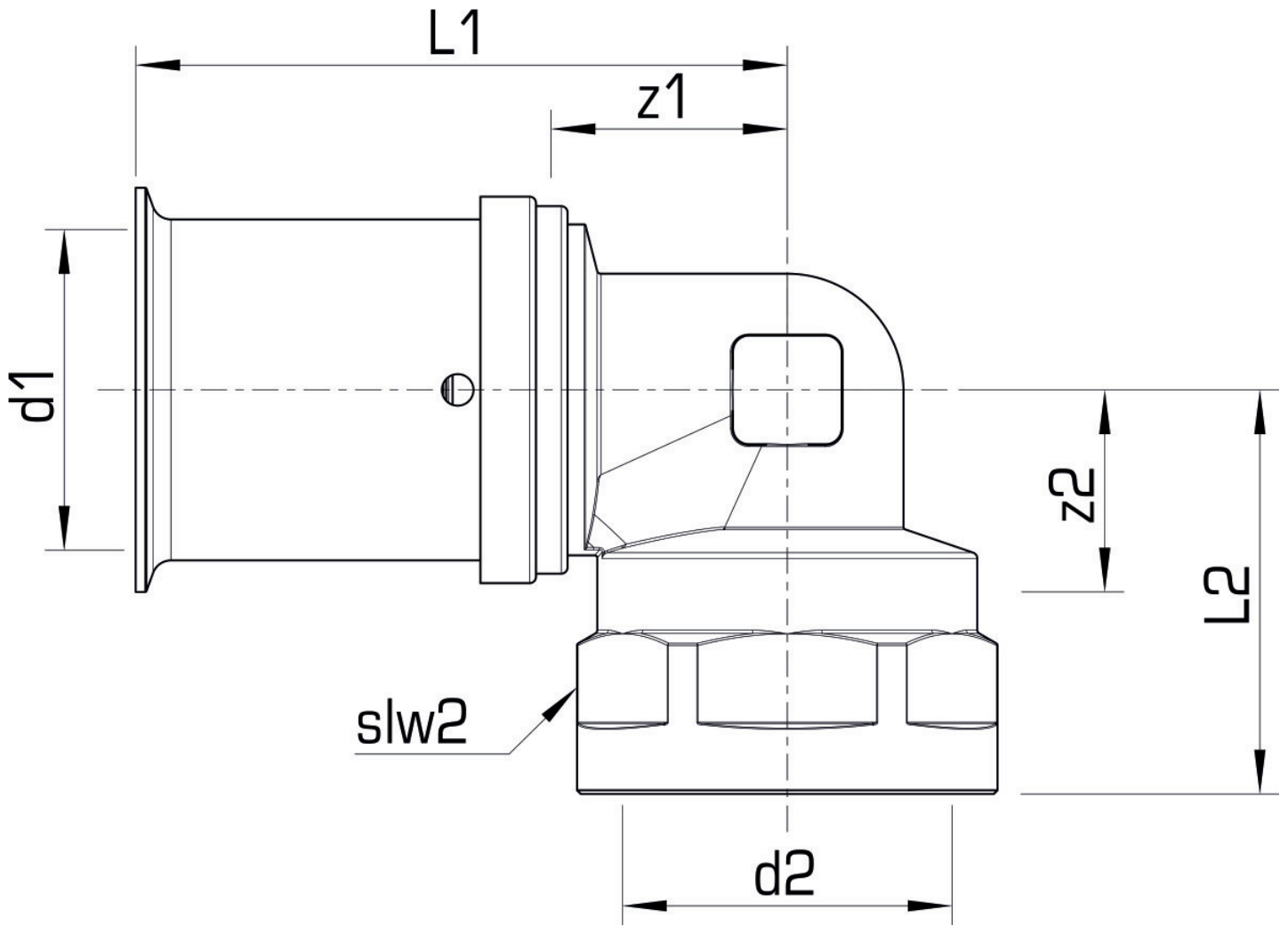

Art. No	label	d2 Inches	d1 mm	L1 mm	L2 mm	z1 mm	z2 mm	slw2 mm
71216D02	20x1/2"	1/2" (15)	20	56	28	30,5	29	24