

CLIMATE FIX

KCP558 CLIMATEFIX climate-hydraulic box 20

6353520

Areas of application

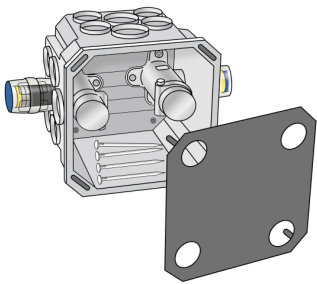

Climate hydraulic box for subsequent hydraulic connection of ceiling panels to the heating or cooling system

Climate hydraulic box consisting of:

Plastic box for wood and steel formwork in in-situ concrete,

2 PROTEC wall bracket fittings with integrated quick-push coupling, closed with quick-push caps,

4 stainless steel nails 120mm and protection cover, pre-assembled in the climate box

Dimensions: L: 115mm W: 115mm H: 102mm

Accessories: KCP558S climate-hydraulic box, transparent lid 130x130x3.5mm

Specifications

Product information	
VPE1	1,00 STK
VPE2	4,00 KT1
weight	0,740 KGM
text	CLIMATEFIX climate-hydraulic box
INTRNR	39232100
main material group	CLIMATEFIX
material group	CLIMATEFIX fittings
code	KCP558

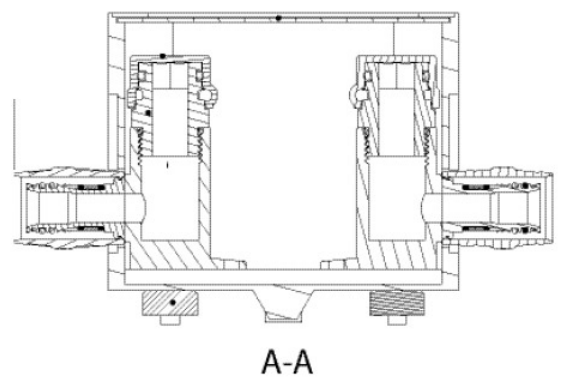
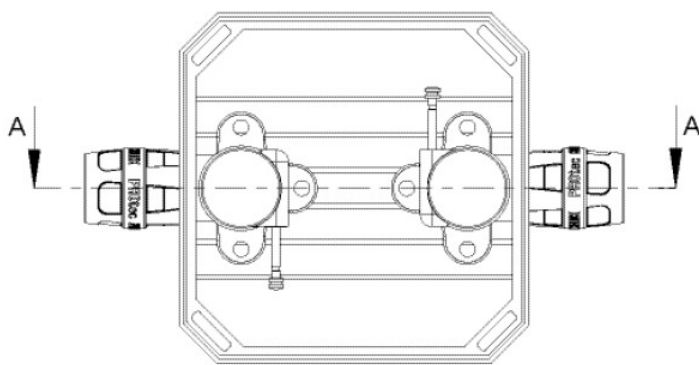
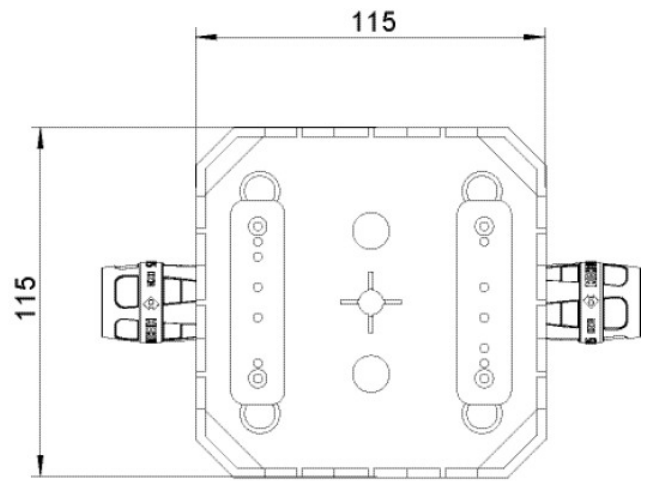
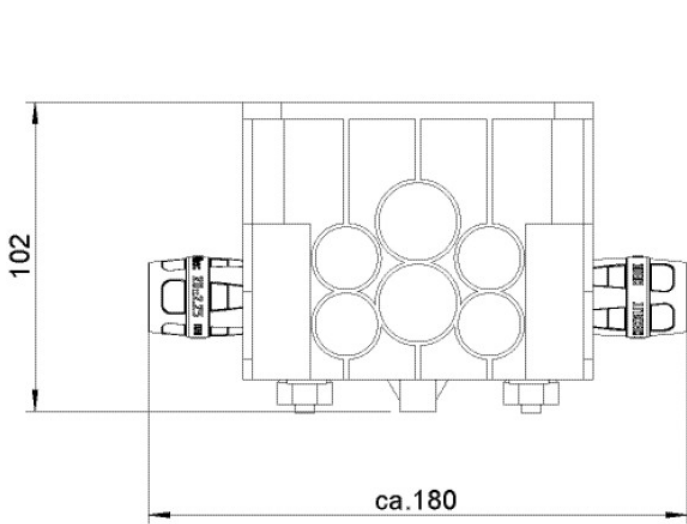

Art. No	label
6353520	20