

KELOX

KM146B KELOX plus pipe - 26mm 25x2.5 blue

75226250

Areas of application

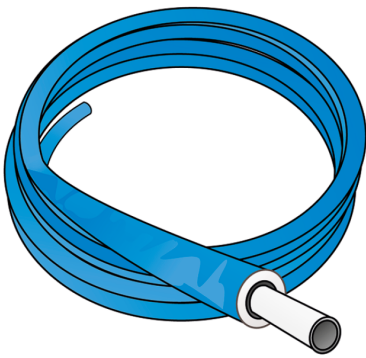

?KELOX multilayer pipe conforming to ÖNORM EN ISO 21003, oxygen- and water vapour diffusion-tight 5-layer PE-RT/Al/PE-RT composite pipe, with factory-applied 26mm closed-cell soft foam insulation and jacket made of viscoplastic PE film

Classification of operating conditions according to ÖNORM EN ISO 21003

Sanitary application - Class 2: 70°C - tmax 80°C/10 bar

Radiator connection - Class 5: 80°C - tmax 90°C/10 bar

Thermal conductivity according to EN ISO 8497:

Average temperature +20°C - 0.038 W/mK

Average temperature +40°C - 0.040 W/mK

Insulation thickness: 26mm

Supplied in coils

Approvals:



Specifications

Article information

color	weiß
colour isolation	blau
flexible	1
trade length	50,00 m
isolation	1

Technical properties

maximum working pressure at 20 ° C	10 bar
thick thermal insulation	26 mm
pipe weight	0,26 kg/m
pipe contents	0,189 l/m
lambda pipe	0,45 W/(m.K)
wall rawness	0,007 mm
expansion coefficient	0,025 mm/(m.K)

Product information

VPE1	25,00 ROL
VPE2	175,00 PAL
L	50 m
weight	0,400 KGM
text	KELOX plus pipe - 26mm
INTRNR	39173900
main material group	KELOX
material group	KELOX isolierte pipes
code	KM146B

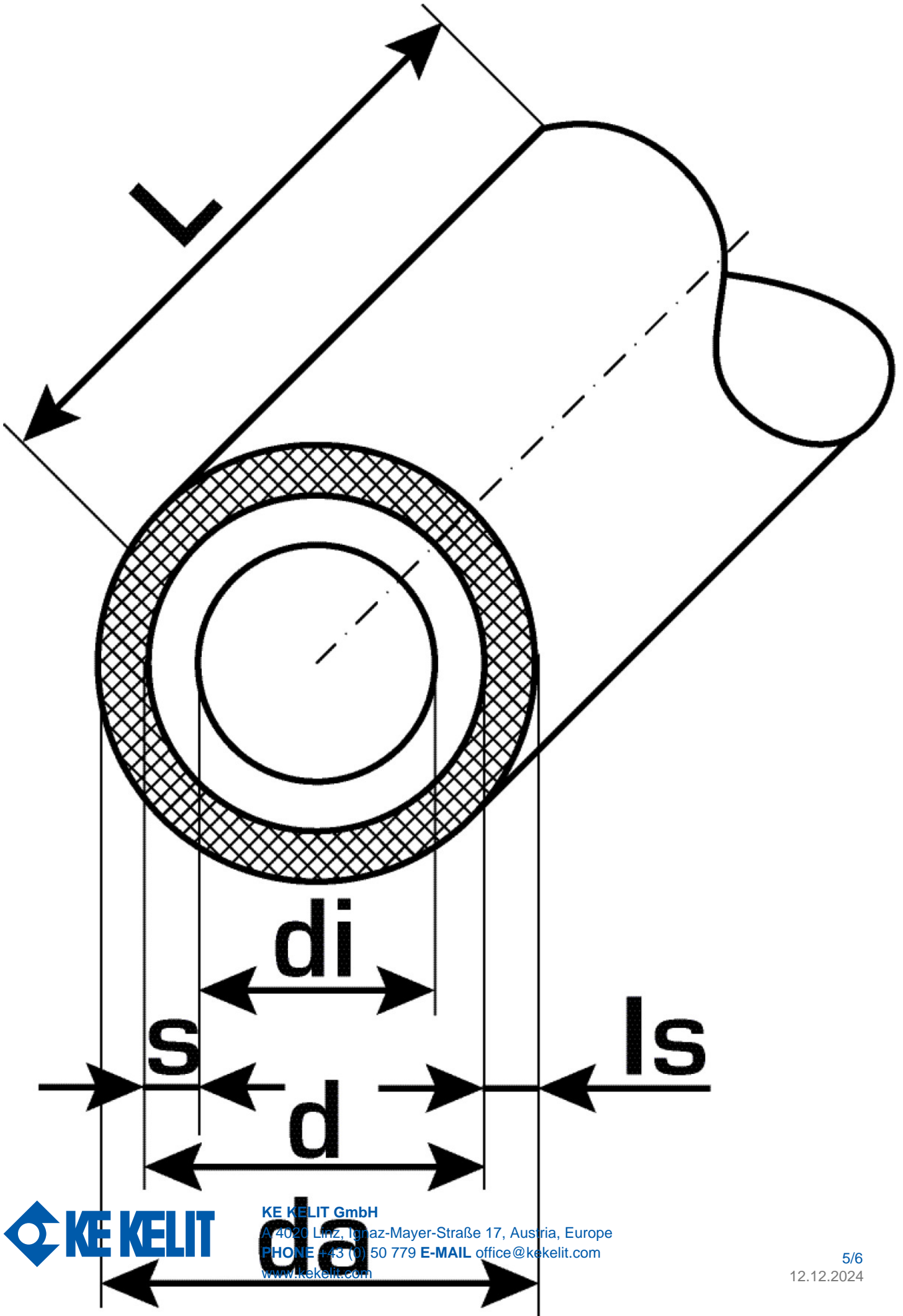

Art. No	label	d1 mm	d Jacket tube mm	pipe contents l/m	s mm
75226250	25x2.5 blue	25	77	0,189	2,5



KE KELIT GmbH

A 4020 Linz, Ignaz-Mayer-Straße 17, Austria, Europe

PHONE +43 (0) 50 779 **E-MAIL** office@kekelit.com

www.kekelit.com