

KELEN

KE08-LX9 KELEN PP-RCT LX-SENSO pipe - PN16 25x3.5

1625091

Areas of application

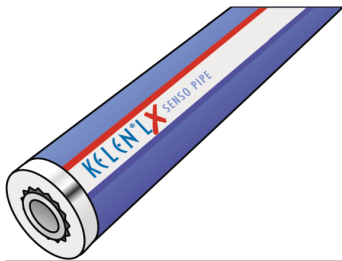

KELEN PP-RCT SENSO drinking water pipe system conforming to ÖNORM EN ISO 15874 made of polypropylene (PP-RCT) with factory-installed 9mm soft-foam insulation, can be located electronically; outer layer consisting of woven tape fabric and viscoplastic polymer alloy

Application area: 20°C/16 bar - 70°C/10 bar

Length: 4m

Approvals:



Specifications

Technical properties

| | |
|----------------------|---------------|
| isolation thickness | 9 mm |
| pipe weight | 0,30 kg/m |
| pipe contents | 0,25 l/m |
| thermal conductivity | 0,039 W/(m.K) |
| diameter inner tube | 25 mm |

Product information

| | |
|---------------------|-----------------------------------|
| DIM2 | 18,0 |
| VPE1 | 48,00 BND |
| VPE2 | 1680,00 HOB |
| L | 4 m |
| weight | 0,291 KGM |
| text | KELEN PP-RCT LX-SENSO pipe - PN16 |
| INTRNR | 39172290 |
| main material group | KELEN |
| material group | KELEN-LX pipes |
| code | KE08-LX9 |

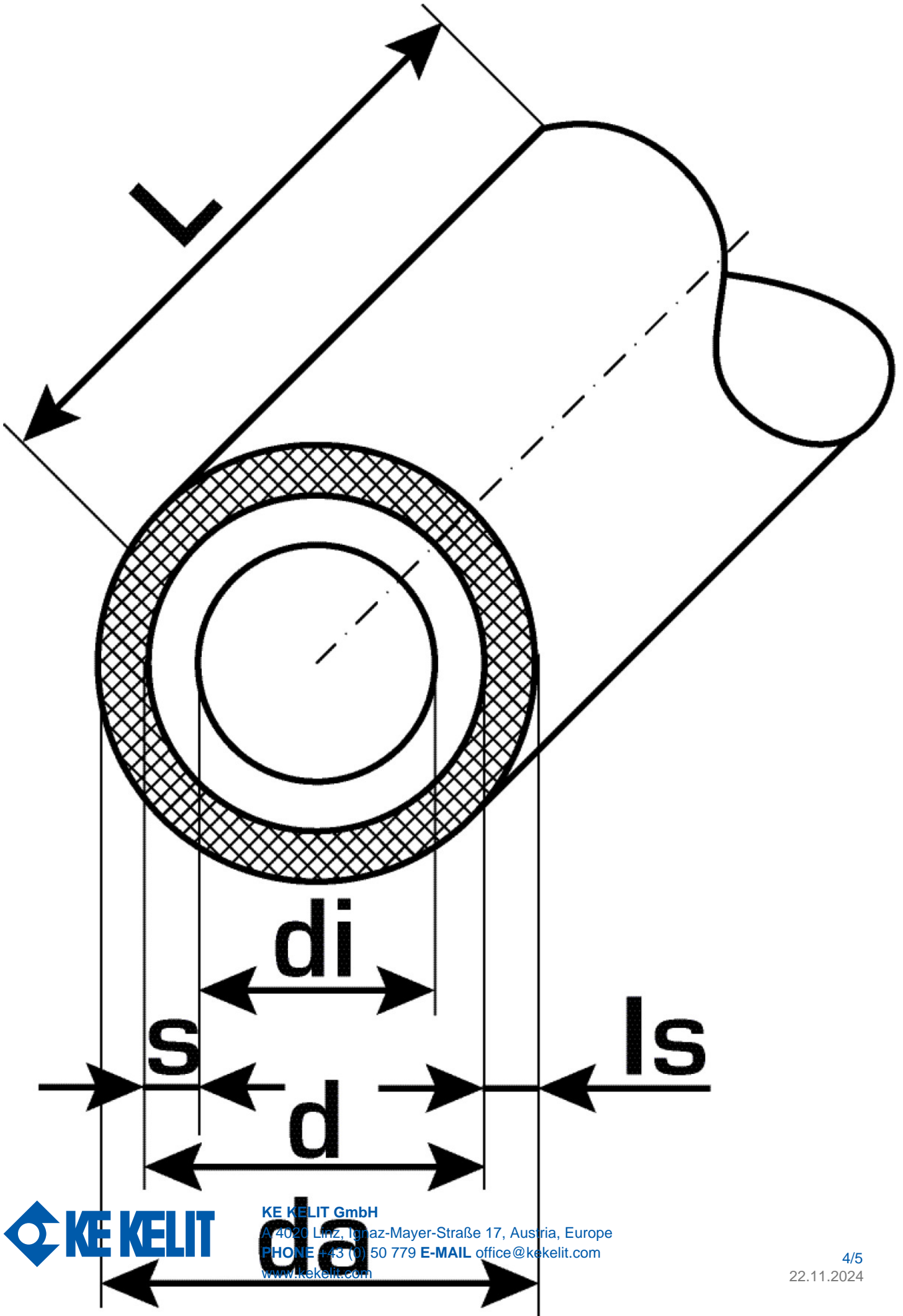

| Art. No | label | d mm | pipe contents l/m |
|---------|--------|------|-------------------|
| 1625091 | 25x3.5 | 18,0 | 0,25 |



KE KELIT GmbH

A 4020 Linz, Ignaz-Mayer-Straße 17, Austria, Europe

PHONE +43 (0) 50 779 **E-MAIL** office@kekelit.com

www.kekelit.com