

KELEN

KE13 KELEN PP-RCT adapter female 63x2"S

2589801

Areas of application



KELEN PP-RCT Polyfusion welding fitting for connecting pipes with fittings made of the same material (no reduction of internal diameter), with injected male thread made of dezincification-resistant brass, non-porous metal plating, threads conform to ÖNORM EN 10226

System parts marked with an "S" are produced with a wrench attachment connection

Do NOT connect to threaded pipes or to cast iron fittings!

Approvals:



KE KELIT GmbH

A 4020 Linz, Ignaz-Mayer-Straße 17, Austria, Europe

PHONE +43 (0) 50 779 E-MAIL office@kekelit.com

www.kekelit.com

Specifications

Article information

| | |
|--------|---|
| port 1 | Kunststoffschweißmuffe |
| port 2 | Innengewinde zylindrisch BSPT-Rp (ISO 7-1 / EN 10226-1) |
| design | gerade |

Product information

| | |
|---------------------|-----------------------------|
| VPE1 | 1,00 SA1 |
| VPE2 | 8,00 KT1 |
| VPE3 | 32,00 KT2 |
| VPE4 | 768,00 PAL |
| weight | 0,750 KGM |
| text | KELEN PP-RCT adapter female |
| INTRNR | 39174000 |
| main material group | KELEN |
| material group | KELEN metal fittings |
| code | KE13 |

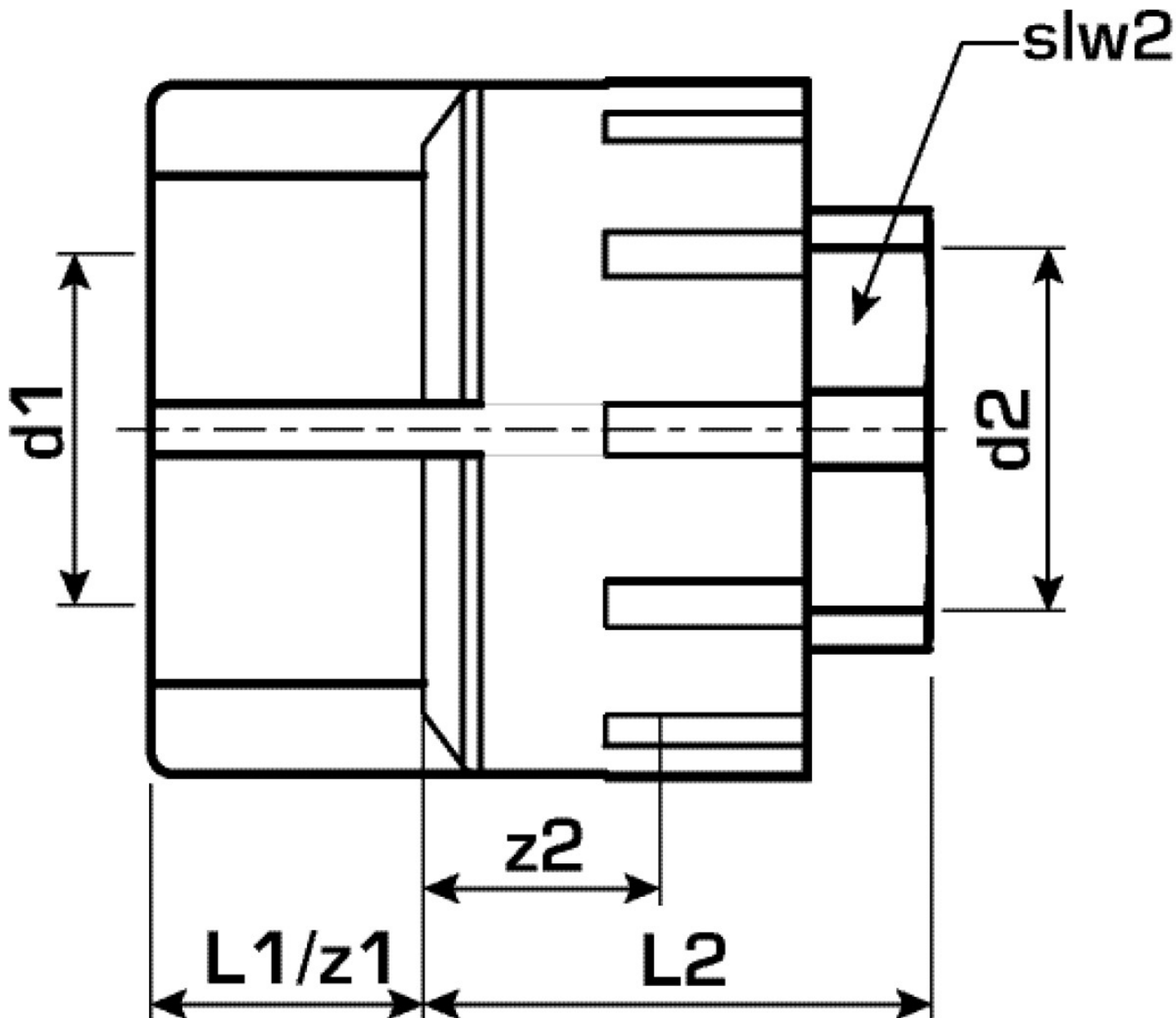

| Art. No | label | d2 | d1 mm | L1 mm | L2 mm | z1 mm | z2 mm | slw2 |
|---------|--------|----|-------|-------|-------|-------|-------|------|
| 2589801 | 63x2"S | 2" | 63 | 30 | 46 | 30 | 30 | 70 |