

# KELEN

## KE51 KELIT PPR ball valve PN16 25

2662201

### Areas of application

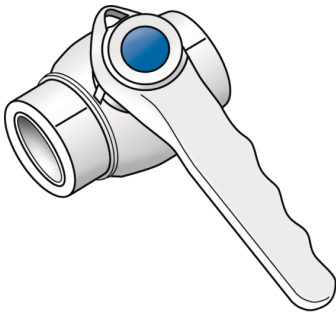

KELIT ball valve polyfusion welding fitting (PP-R), connecting pipes and fittings made of the same material without narrowing the cross section, compatible with KELEN and KETRIX

ATTENTION: Not suitable for minus temperatures

### Approvals:



KE KELIT GmbH

A 4020 Linz, Ignaz-Mayer-Straße 17, Austria, Europe

PHONE +43 (0) 50 779 E-MAIL [office@kekelit.com](mailto:office@kekelit.com)

[www.kekelit.com](http://www.kekelit.com)

# Specifications

## Article information

port 1	Kunststoffschweißmuffe
port 2	Kunststoffschweißmuffe
execution	gerade

## Product information

VPE1	5,00 SA1
VPE2	20,00 KT1
VPE3	80,00 KT2
weight	0,189 KGM
text	KELIT PPR ball valve PN16
INTRNR	39174000
main material group	KELEN
material group	KELEN metal fittings
code	KE51



**KE KELIT GmbH**

A 4020 Linz, Ignaz-Mayer-Straße 17, Austria, Europe

**PHONE** +43 (0) 50 779 **E-MAIL** [office@kekelit.com](mailto:office@kekelit.com)

[www.kekelit.com](http://www.kekelit.com)

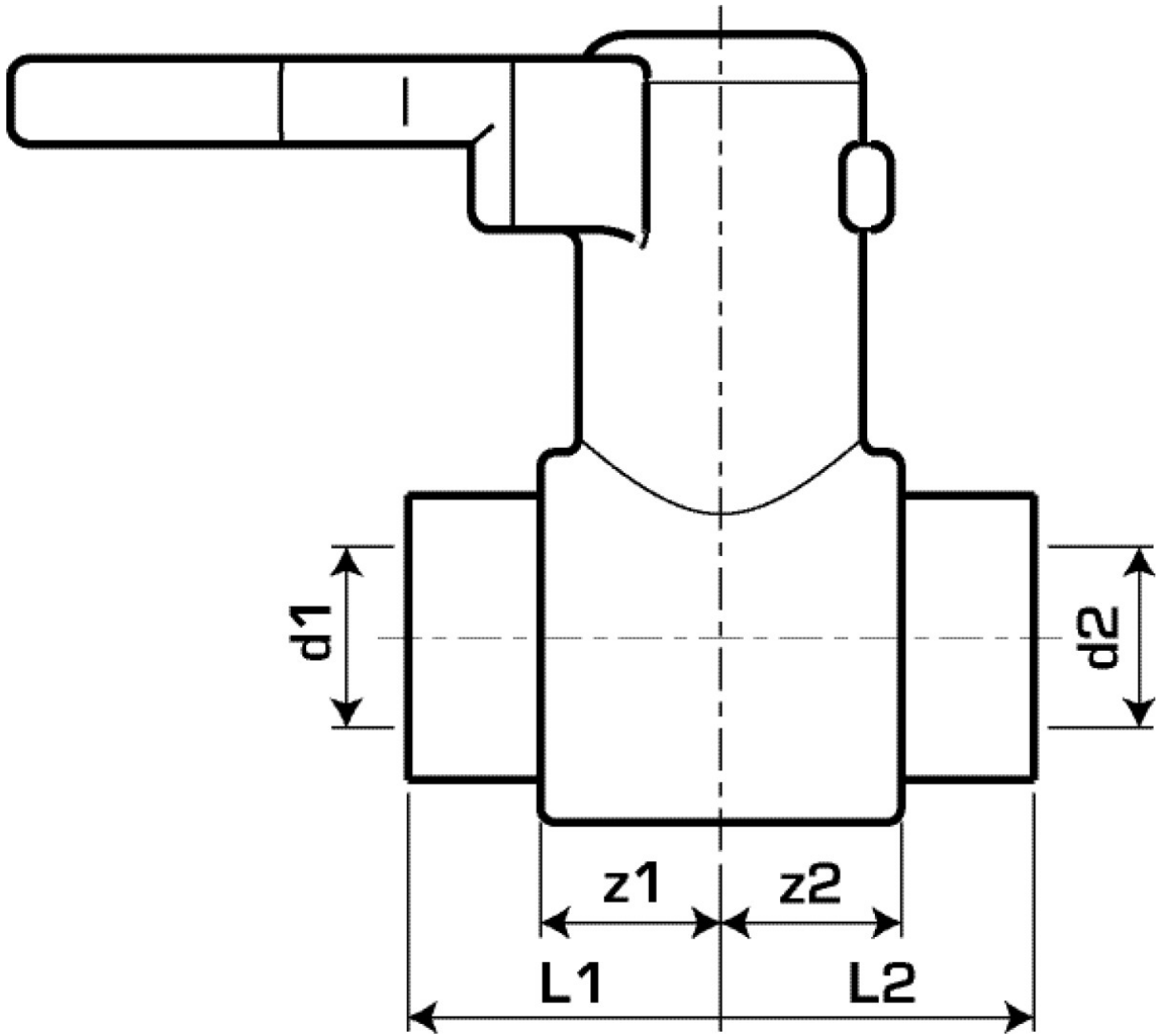

Art. No	label	d1 mm	d2 mm	L1 mm	L2 mm	z1 mm	z2 mm
2662201	25	25	25	35	35	14	14