

# KELEN

## KE51 KELEN PPR ball valve PN16 50

2662501

### Areas of application

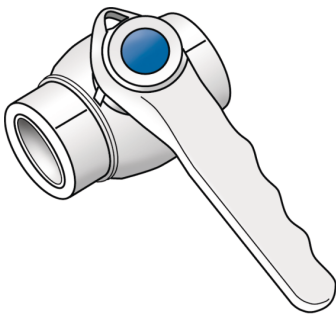

KELEN ball valve polyfusion (PP-R) moulded fitting for connecting pipes and fittings made of the same material without narrowing the cross section.

### Approvals:



# Specifications

## Article information

port 1	Kunststoffschweißmuffe
port 2	Kunststoffschweißmuffe
execution	gerade

## Product information

VPE1	2,00 SA1
VPE2	8,00 KT1
VPE3	32,00 KT2
weight	0,923 KGM
text	KELEN PPR ball valve PN16
INTRNR	39174000
main material group	KELEN
material group	KELEN metal fittings
code	KE51

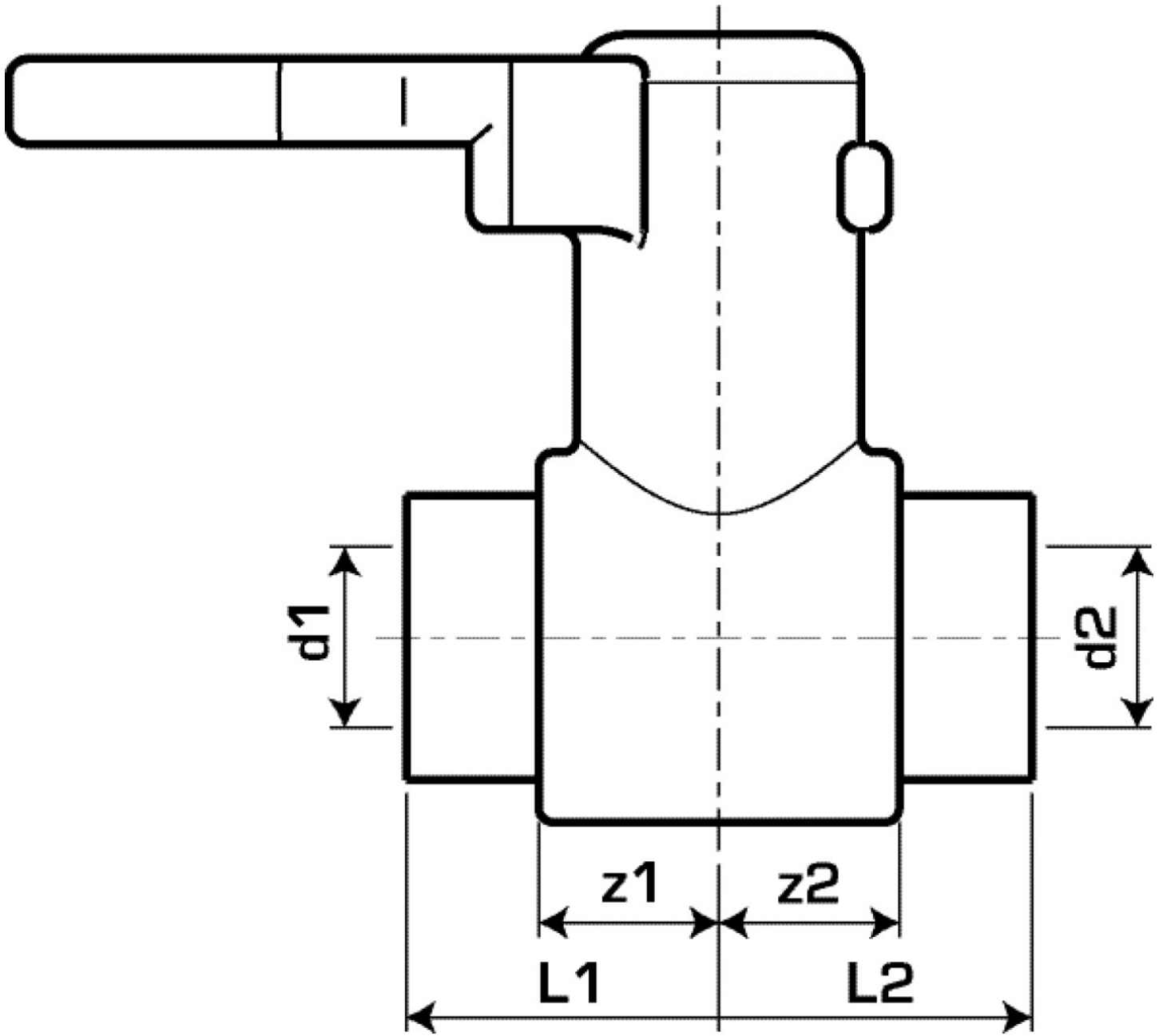

Art. No	label	d1 mm	d2 mm	L1 mm	L2 mm	z1 mm	z2 mm
2662501	50	50	50	58	58	33	33