

KELEN

KE52 KELEN PP-RCT slanted seat valve with fitting connection KE57 32-DN25

2670321

Areas of application

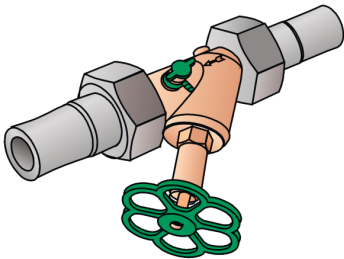

KELEN PP-RCT Polyfusion welding fitting, with fitting screw connections KE57 flat sealing, top part "dead space-free", incl. EPDM seal and outflow plastic socket or EPDM seal available separately!

Approvals:



KE KELIT GmbH

A 4020 Linz, Ignaz-Mayer-Straße 17, Austria, Europe

PHONE +43 (0) 50 779 E-MAIL office@kekelit.com

www.kekelit.com

Specifications

Product information	
VPE1	1 SA1
VPE2	5 KT1
VPE3	20 KT2
VPE4	480 PAL
weight	1,137 KGM
text	KELEN PP-RCT slanted seat valve with fitting connection KE57
INTRNR	84818079
main material group	KELEN
material group	KELEN metal fittings
code	KE52

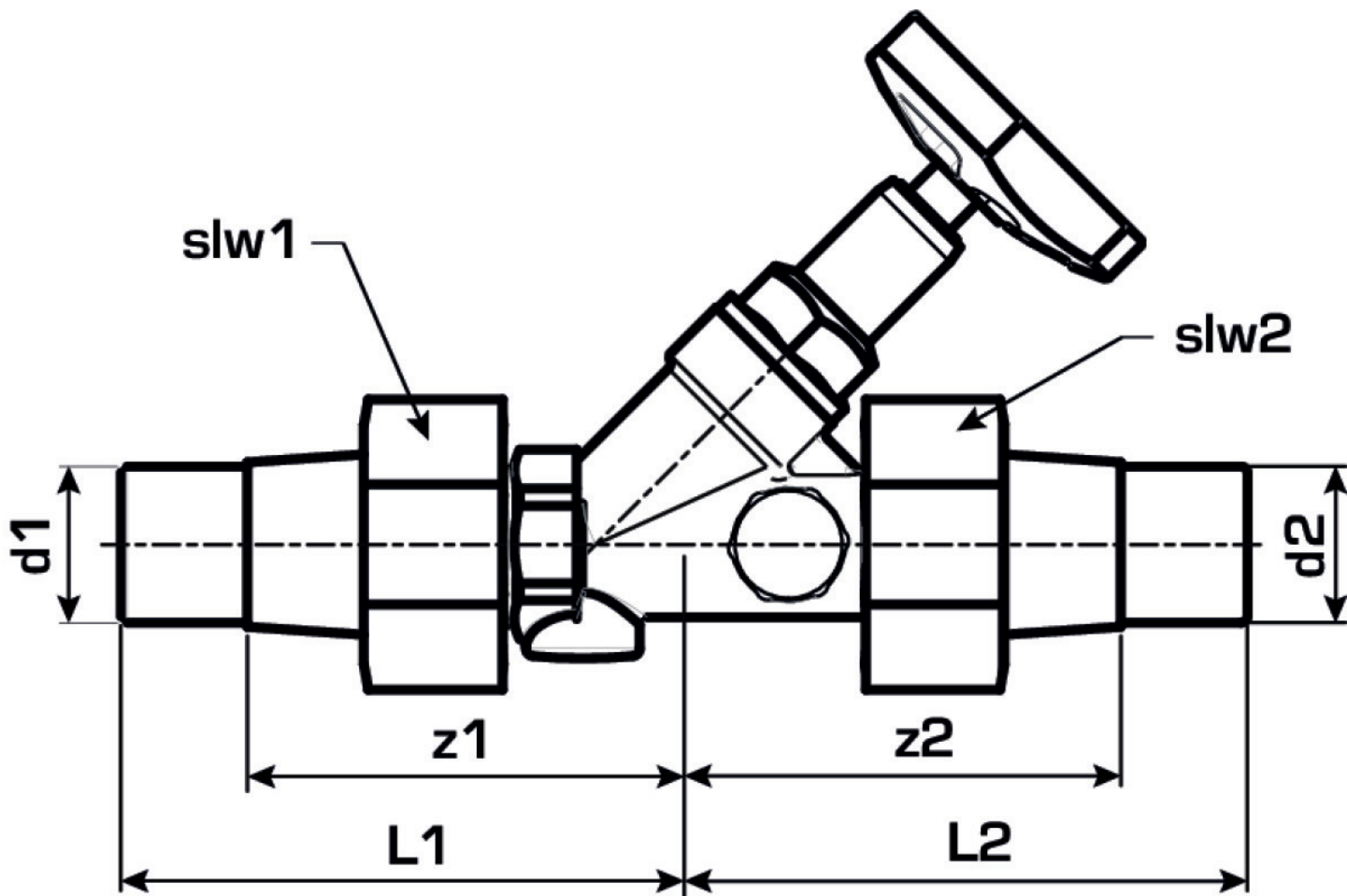

Art. No	label	L1 mm	L2 mm	z1 mm	z2 mm	slw1	slw2
2670321	32-DN25	107	107	81	81	52	52