

KELOX

KM130 KELOX plus pipe - 9mm 16x2

7521161

Areas of application



?KELOX multilayer pipe conforming to ÖNORM EN ISO 21003, oxygen- and water vapour diffusion-tight 5-layer PE-RT/Al/PE-RT composite pipe, with factory-applied 9mm closed-cell soft foam insulation and jacket made of viscoplastic PE film

Classification of operating conditions according to ÖNORM EN ISO 21003

Sanitary application - Class 2: 70°C - tmax 80°C/10 bar

Radiator connection - Class 5: 80°C - tmax 90°C/10 bar

Insulation thickness: 9mm

Colour: red

Supplied in coils



KE KELIT GmbH

A 4020 Linz, Ignaz-Mayer-Straße 17, Austria, Europe

PHONE +43 (0) 50 779 E-MAIL office@kekelit.com

www.kekelit.com

Approvals:



Specifications

Article information

color White

colour isolation Red

flexible 1

isolation 1

Technical properties

maximum working pressure at 20 ° C 10 bar

thick thermal insulation 9 mm

pipe weight 0,18 kg/m

pipe contents 0,113 l/m

lambda pipe 0,45 W/(m.K)

wall rawness 0,007 mm

expansion coefficient 0,025 mm/(m.K)

Product information

VPE1	50,00 ROL
VPE2	700,00 PAL
L	50 m
weight	0,165 KGM
text	KELOX plus pipe - 9mm
INTRNR	39173900
main material group	KELOX
material group	KELOX isolierte pipes
code	KM130

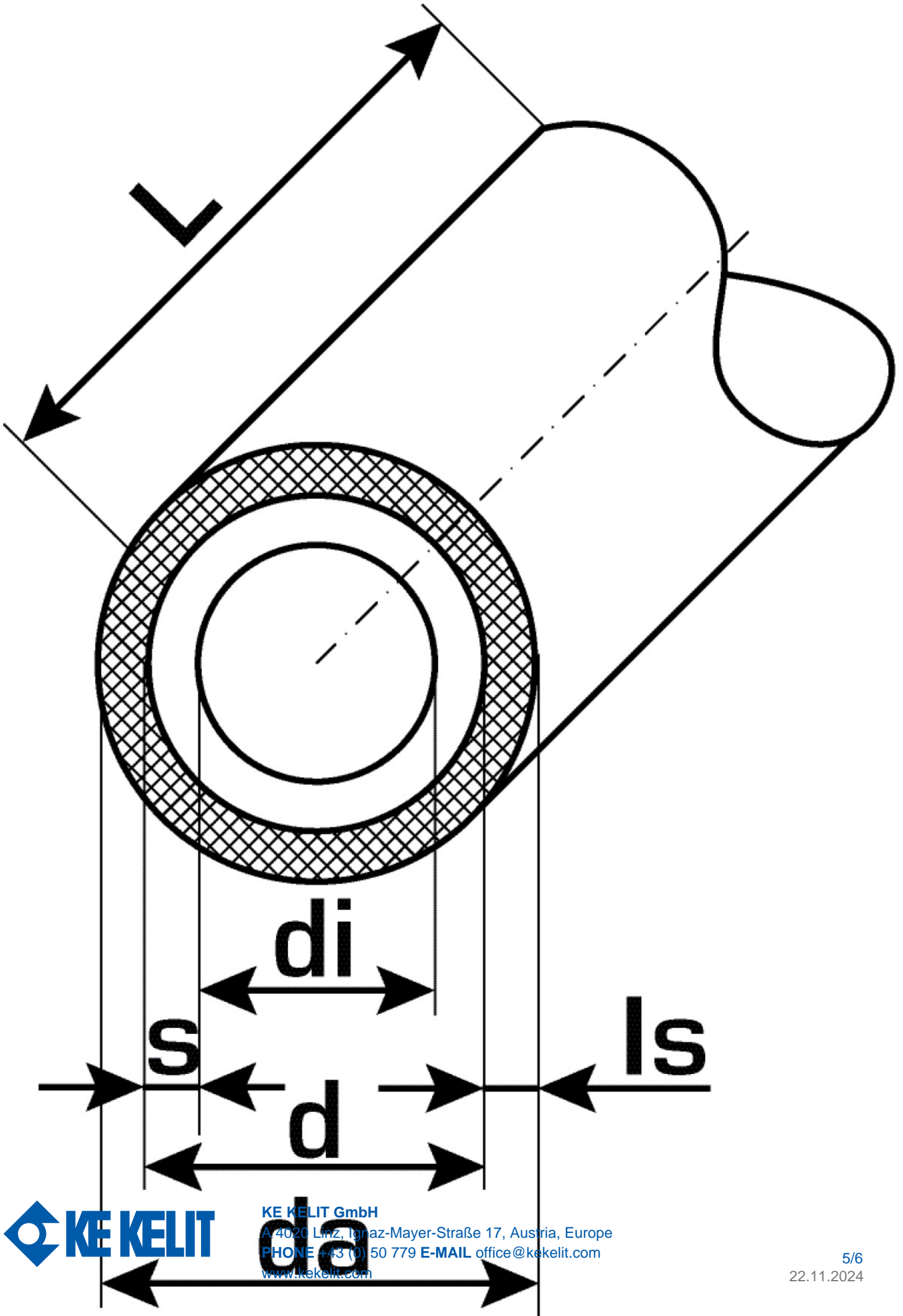

Art. No	label	d1 mm	d Jacket tube mm	pipe contents l/m	s mm
7521161	16x2	16	34	0,113	2



KE KELIT GmbH

A 4020 Linz, Ignaz-Mayer-Straße 17, Austria, Europe

PHONE +43 (0) 50 779 **E-MAIL** office@kekelit.com

www.kekelit.com