

# KELOX

## KM547 KELOX flush-mounted wall block 16 Type 1

9006500

### Areas of application

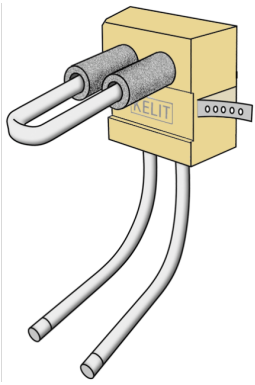

?Insulating wall block for valve radiators to be installed before plaster work is done; including inlaid d16 KELOX multilayer pipes between the feed line and return line, for subsequent connection of the radiators, suitable for flush mounting

Type 1: W: 110mm, H: 200 mm, D: 50mm - pipe 500mm, elbow 150mm

Type 2: W: 100mm, H: 120 mm, D: 35mm - pipe 500mm, elbow 250mm

Type 3: W: 110mm, H: 200 mm, D: 50mm - pipe 500mm, elbow 250mm

# Specifications

Product information	
VPE1	1,00 KT1
VPE2	10,00 KT2
weight	0,230 KGM
text	KELOX flush-mounted wall block
INTRNR	39174000
main material group	KELOX
material group	KELOX accessories
code	KM547

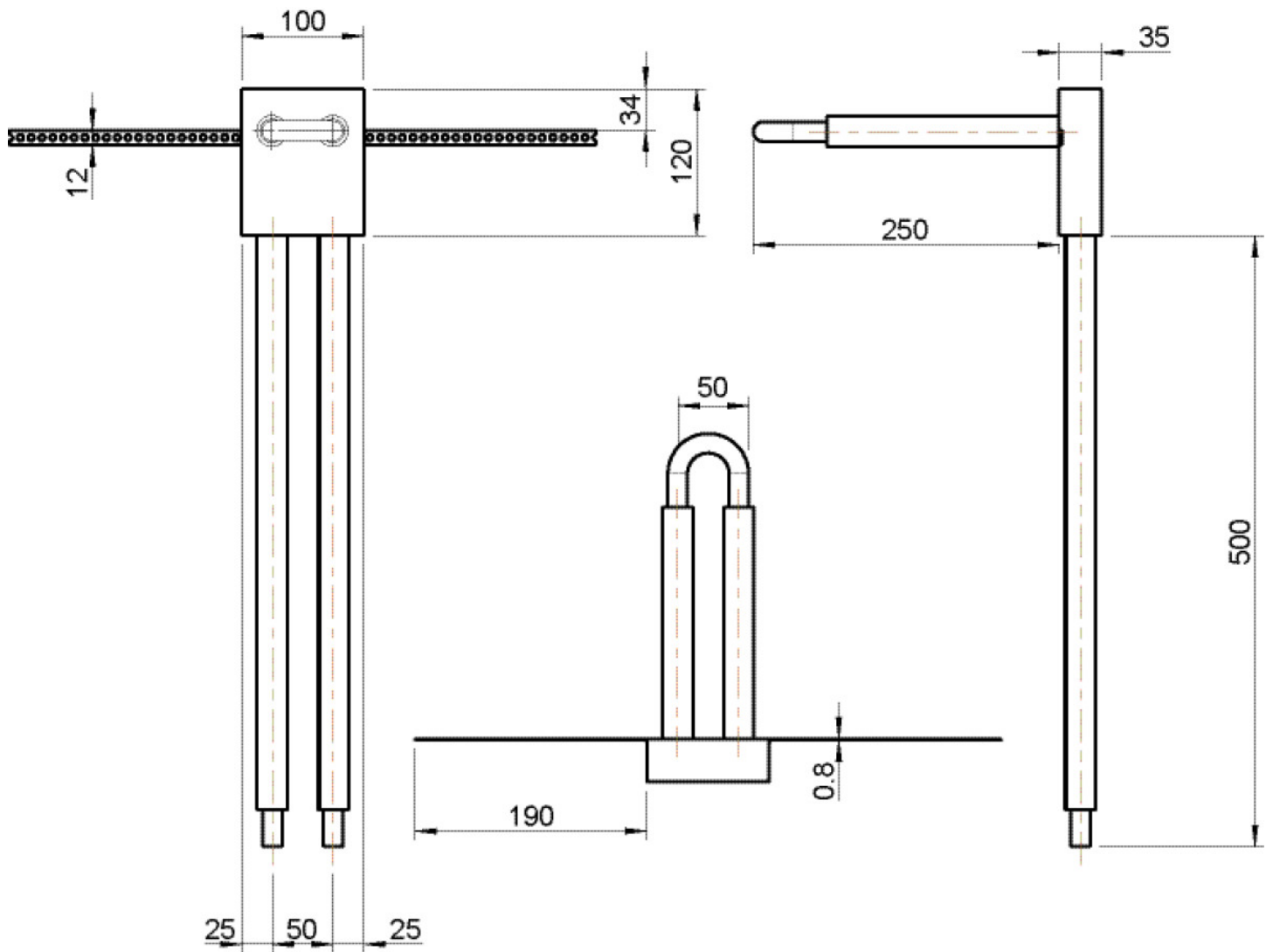

Art. No	label
9006500	16 Type 1