

# KELOX

## KMP447 KELOX-PROTEC adapter tee female 32x3/4"

73240F04

### Areas of application

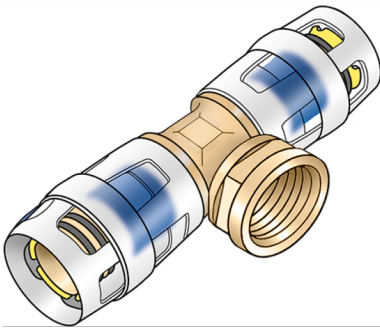

Push-in tee with female thread, made of dezincification-resistant brass (DZR); incl. push-on sleeve made of transparent polyamide, O-rings, withdrawal barriers and protector ring as insertion locking device

DO NOT screw in any threaded pipes and cast iron fittings!

## Approvals:



# Specifications

## Article information

port 1	Plug-in
port 2	Female thread metric
port 3	Plug-in
execution	Tee piece
angle	90 °

## Technical properties

maximum working pressure at 20 ° C	10 bar
------------------------------------	--------

## Product information

VPE1	4,00 SA1
VPE2	32,00 KT1
weight	0,250 KGM
text	KELOX-PROTEC adapter tee female
INTRNR	74122000
main material group	KELOX
material group	KELOX-PROtec pushfittings
code	KMP447



Art. No	label	d2	d1 mm	d3 mm	L1 mm	L2 mm	L3 mm	z1 mm	z2 mm	z3 mm	slw1 mm
73240F0	32x3/4"	3/4" (20)	32	32	60,5	39	60,5	21,5	22,5	21,5	30